

WIND COMFORT STUDIES

Extended Land Beaufort Scale showing wind effects on people.

Beaufort Number	Description	Wind Speed at 1.75m height (m/s)	Effect on people
0	Calm	0.0–0.1	
1	Light air	0.2–1.0	No noticeable wind
2	Light breeze	1.1–2.3	Wind felt on face
3	Gentle breeze	2.4–3.8	Hair disturbed, clothing flaps, newspaper difficult to read
4	Moderate breeze	3.9–5.5	Raises dust and loose paper, hair disarranged
5	Fresh breeze	5.6–7.5	Force of wind felt on body, danger of stumbling when entering a windy zone
6	Strong breeze	7.6–9.7	Umbrellas used with difficulty, hair blown straight, difficult to walk steadily, sideways wind force about equal to forwards walking force, wind noise on ears unpleasant
7	Near gale	9.8–12.0	Inconvenience felt when walking
8	Gale	12.1–14.5	Generally impedes progress, great difficulty with balance in gusts
9	Strong gale	14.6–17.1	People blown over

Discomfort threshold

$$U_e = U + k \sigma_u > U_{THR}$$

U_e is the equivalent wind speed,

U is the mean wind speed,

k is the peak factor proposed $k = 1$

σ_u is the standard deviation of the wind speed (turbulence)

U_{THR} is the threshold value (all values at pedestrian height).

Discomfort threshold for walking:

$$U_e = U + \sigma_u > 6 \text{ m/s}, \quad P_{max} = 15\%$$

σ_u [m/s] the **standard deviation of wind speed (turbulence)** at pedestrian level

is approximately constant. σ_u at the building site can be assumed equal to σ_u at the meteorological site. It can be taken equal to $2.4 u^*$ where $u^* = (\tau_0/\rho)^{0.5}$ friction velocity (at $U = 6 \text{ m/s}$, $\sigma_u \approx 1 \text{ m/s}$).

P [%] **discomfort probability** the percentage of hours (during a year) in which the thresholds are exceeded

Control of walking threshold:

$$U + 3 \sigma_u > 15 \text{ m/s}, \quad P_{max} = 0,1\%$$

Danger threshold

$$U + 3 \sigma_u > 20 \text{ m/s}, \quad P_{\max} = 0,1\%$$

Determination of Local Wind Data

Wind amplification factor

$$\gamma = \frac{U}{U_{\text{pot}}}$$

where

U the local mean wind speed at given locations of building site

U_{pot} mean wind speed measured at the meteorological site

U/ U_{pot} can be split into two factors:

- U/U_0 a design related contribution: influence of the building geometry, building orientation, the interaction between buildings (determined by wind tunnel model measurements or by CFD)
- U_0/U_{pot} terrain-related contribution, influence of differences in terrain roughness between the meteorological site and the terrain surrounding the building site and that of the features of terrain (determined by using Eurocode)

$$\gamma = \frac{U}{U_{\text{pot}}} = \frac{U}{U_0} \frac{U_0}{U_{\text{pot}}}$$

U_0 is a reference wind speed that is taken at a certain distance upstream of the building site (e.g. approaching wind velocity at WT measurement).

Wind Tunnel Measurement Methods for Pedestrian Wind

Methods can be divided into two groups

- A) Point methods: quantitative data at discrete locations in the flow field (hot-wire anemometers, hot-film anemometers, pressure sensors)
- B) Area methods: complete visualization of the pedestrian level wind flow over the entire area concerned
 - sand erosion techniques,
 - oil streaks.

A) Sand erosion method

Two steps:

- Calibration: wind tunnel floor (without building model) is covered with a uniform fine layer of dried sand and wind tunnel speed v_{wt} is increased in steps until at a certain wind speed value v_{wte} the sand is blown away.
- building model is placed on the turntable and the floor is sprinkled again with an uniform fine layer of sand. Wind tunnel speed is increased in steps ($v_{\text{wt}1}, v_{\text{wt}2}, v_{\text{wt}i}, \dots$) and sand erosion occurs. The areas in the flow field where sand is eroded are then registered by photography.

From this information, a rough idea of the local amplification factor (local wind speed divided by the wind speed that would occur at the same location if the buildings were absent) can be obtained:

$$\gamma_i = V_{wt,e} / V_{wti}$$

B) Oil streak technique: coating the wind tunnel floor around the model with a mixture of TiO₂, oil and petroleum. Wall shear stress moves the mixture over the turntable, while the petroleum evaporates. The result is a pattern of streaks clearly showing the mean direction of the wind flow near the floor. Shape and density provides information on the turbulence in the flow.

The oil streak technique can be used in addition to the scour technique that provides no directional information.

Flow around a slab block screened by a low building

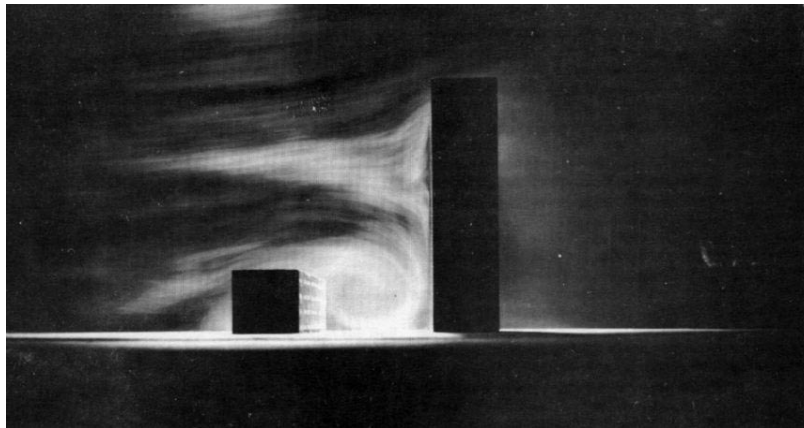

Flow around a slab block screened by a low building visualized by smoke in the wind tunnel

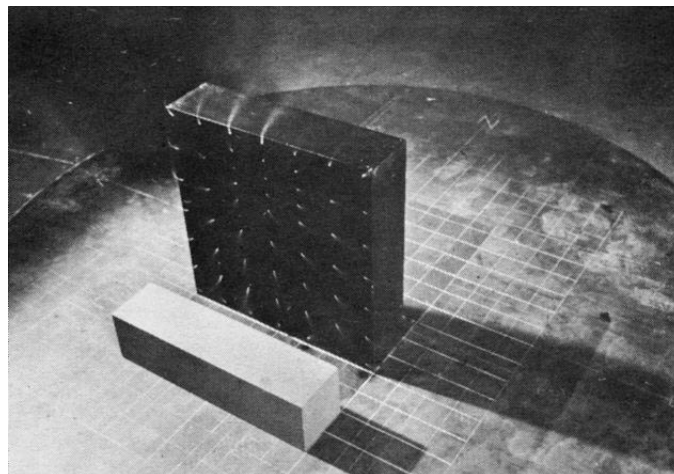

Flow field on the front face of a slab around the stagnation point is visualized by smoke injected into the airstream from small orifices.

Two phenomena can be observed:

- (1) **The division of the flow** on windward face of the slab: **stagnation point at about 2/3 of the height**
- (2) The flow divides: some of it passing upwards, some passing sideward and the remainder **descending to the base of the slab**;
- (3) The large **standing vortex** in the space between the low building and the slab that is **generated by the down-flow of air from the stagnation point**.

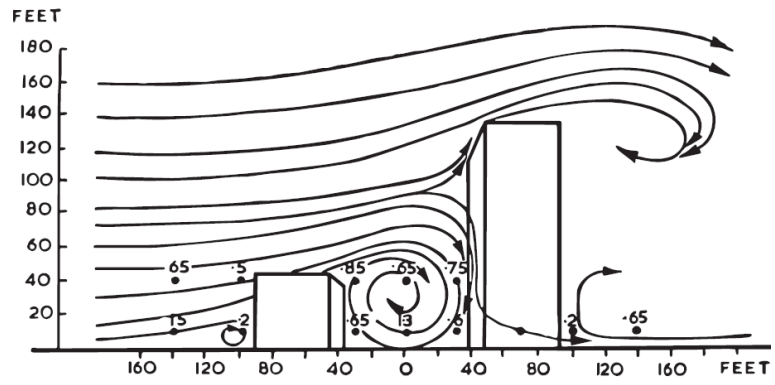

Wind amplification factor $AF = 1,3$ in standing vortex, $AF = 1.6$ in the corner streams.

Wind Flow around a Single High-rise Rectangular Buildings

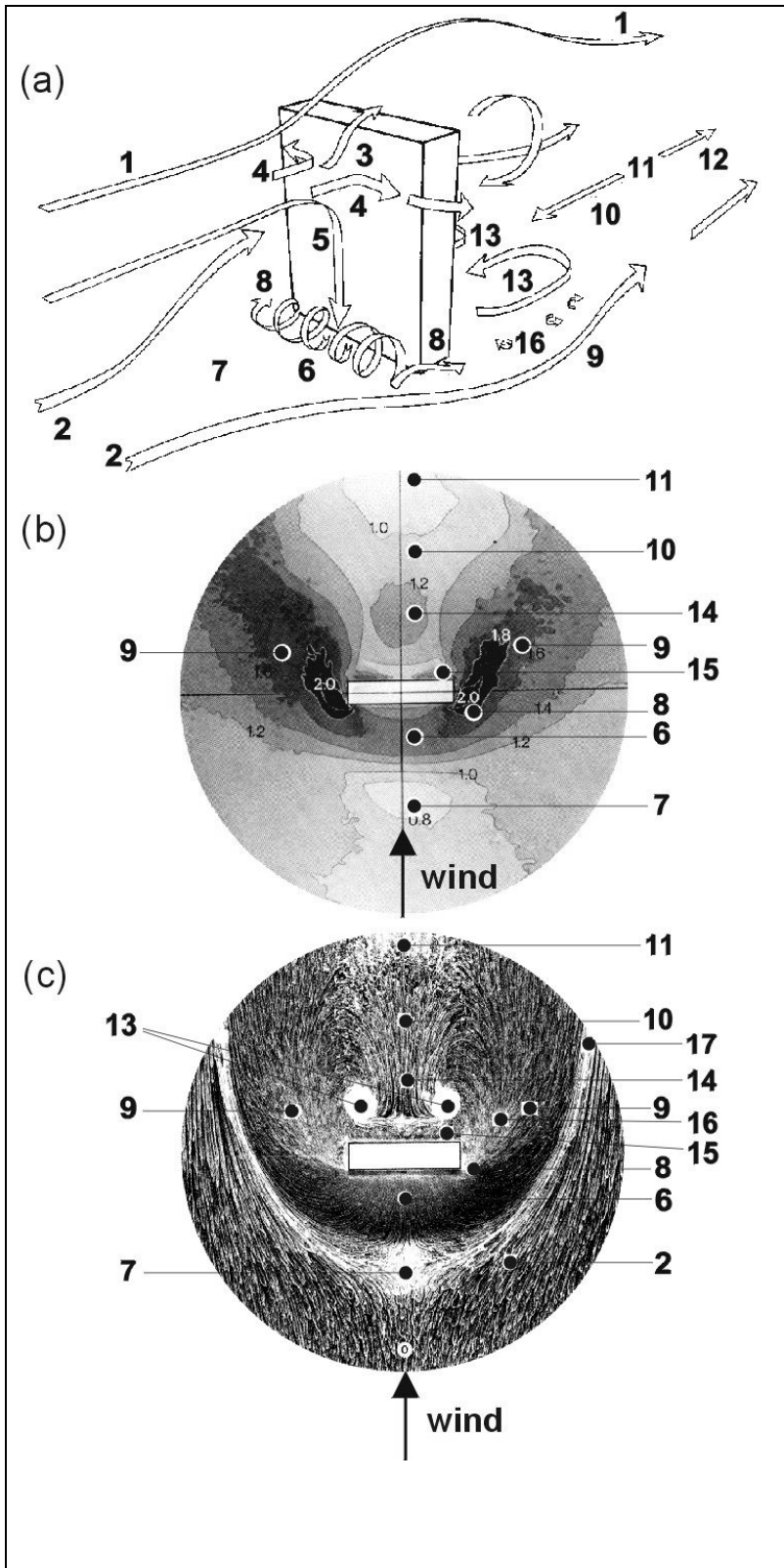

$L \times B \times H = 80 \times 20 \times 70 \text{ m}^3$

Part of the flow is deviated over the building (1) and part of it flows around the building (2).

Stagnation point at about 70% of the building height. From this point, the flow is deviated to the lower pressure zones of the facade: upwards (3), sideways (4) and downwards (5).

Air flowing downwards feeds a **standing vortex** at ground level (6) (**frontal vortex or horseshoe vortex**) caused by boundary layer separation.

Flow direction near ground level is opposite to the direction of the approach flow.

Stagnation point is created at the ground in front of the building (7).

The horseshoe vortex stretches out sideways and sweeps around the corners where flow separation occurs and **corner streams** with high wind speed values are created (8).

The corner streams merge into the general flow around the corners (9).

At the leeward side an **under-pressure zone (separation bubble)** is created. As a result, **backflow** occurs (10,13). The backflow is also responsible for the creation of **slow rotating vortices** behind the building (13).

Stagnation zone is downstream of the building at ground level where the flow directions are opposite and low wind speeds exist (14).

Beyond the stagnation zone, the flow resumes its normal direction but wind speeds stay low for a considerable distance behind the building (i.e. the **far wake**) (12).

Between these vortices and the corner streams (9), a zone with a high velocity gradient exists (the **shear layer**) that comprises small, **fast rotating vortices** (16). The shear layers originate at the building corners where flow separation occurs.

Pedestrian level wind investigated by **sand erosion technique** presents contours of **local amplification factor**. **Oil streak technique** was used for the same building.

(a)

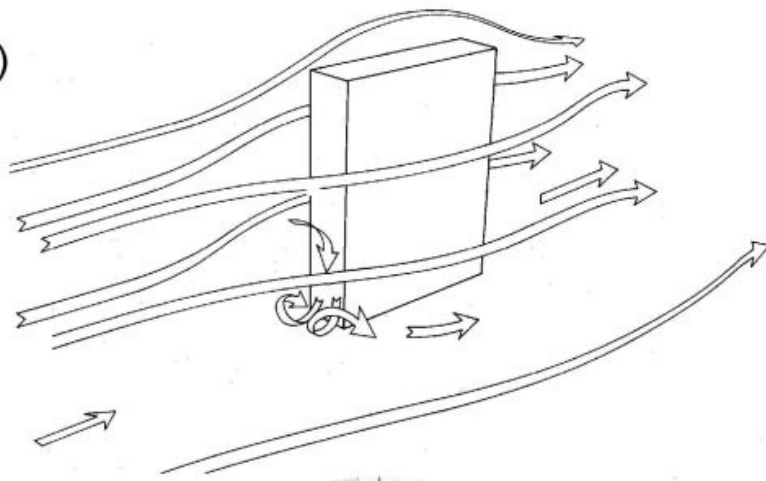

Flow pattern around a narrow high-rise building in urban terrain
 $L \times B \times H = 10 \times 80 \times 50 \text{ m}^3$.

In this case, the flow is deflected sideways due to the narrow windward facade.

The **standing vortex** is hardly present and the flow rapidly resumes its normal direction (small **influence area**).

The **corner streams** are small in area but high peak values appear to exist just downstream of the building corners.

(b)

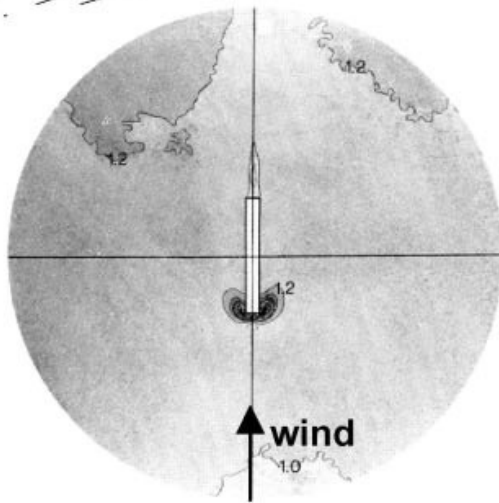

(c)

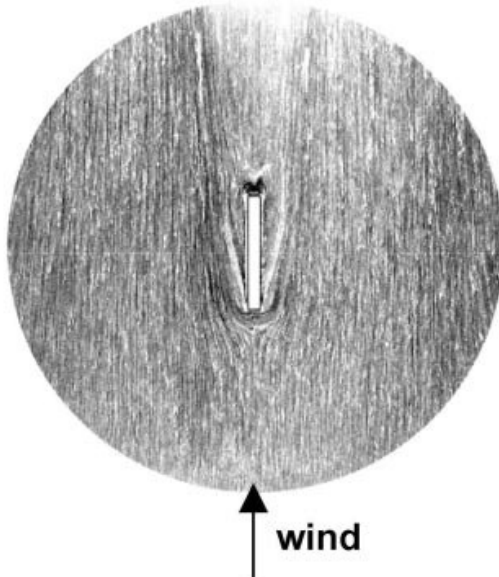

Flow pattern around a wide and lower building

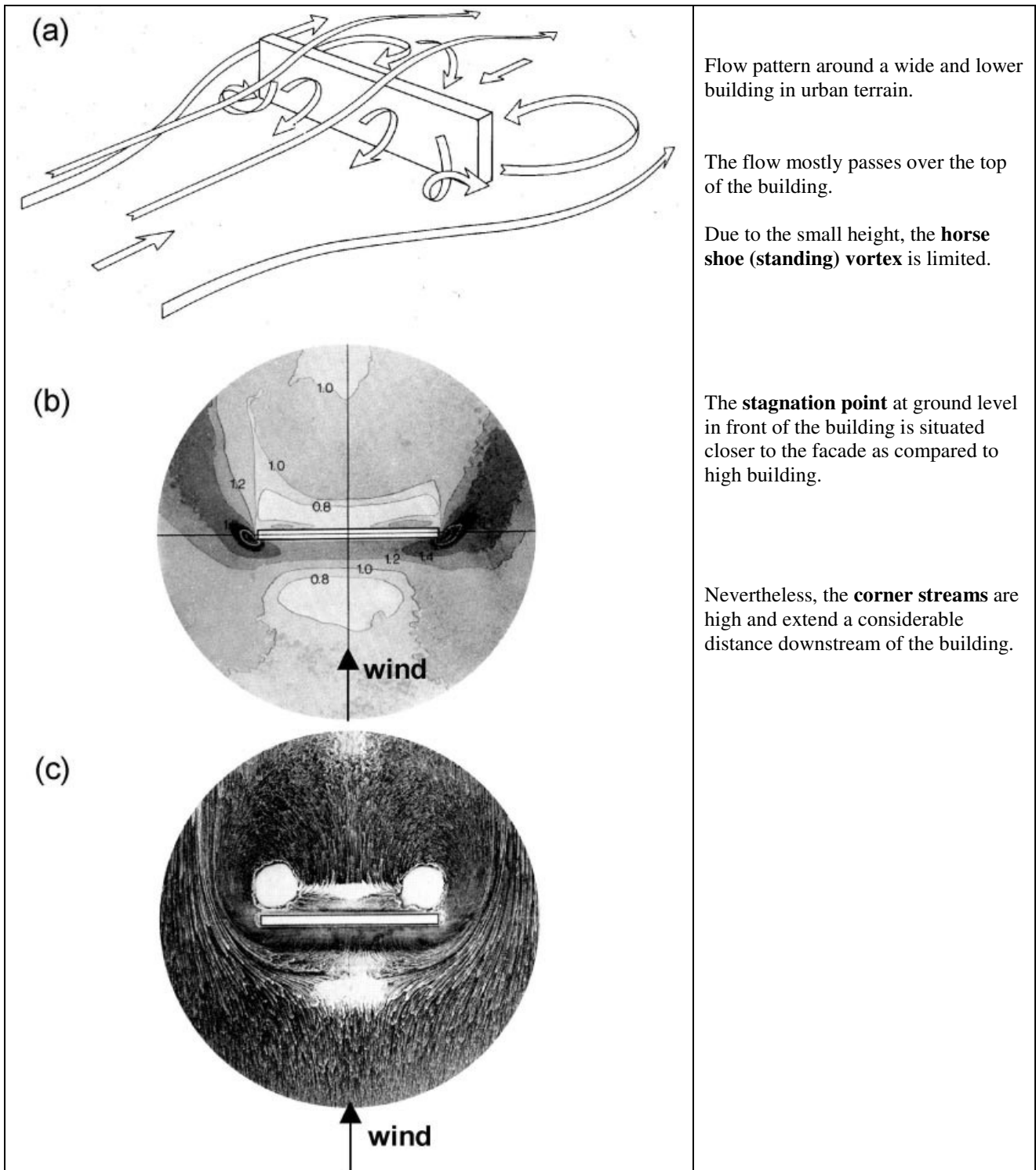

PASSAGES THROUGH A BUILDING

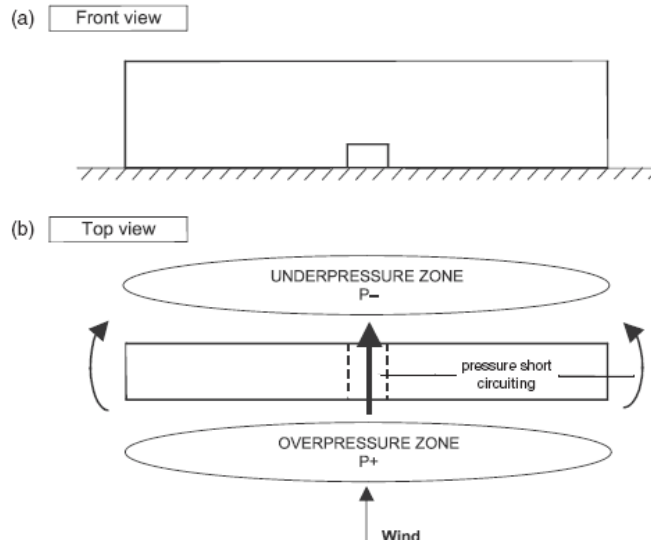

Schematic representation of **pedestrian level wind flow** for a building with a **through-passage**.

The flow through the passage is caused by „**pressure short-circuiting**” between windward (overpressure) and leeward (underpressure) facade. **Corner streams** are also caused by „**pressure short-circuiting**”.

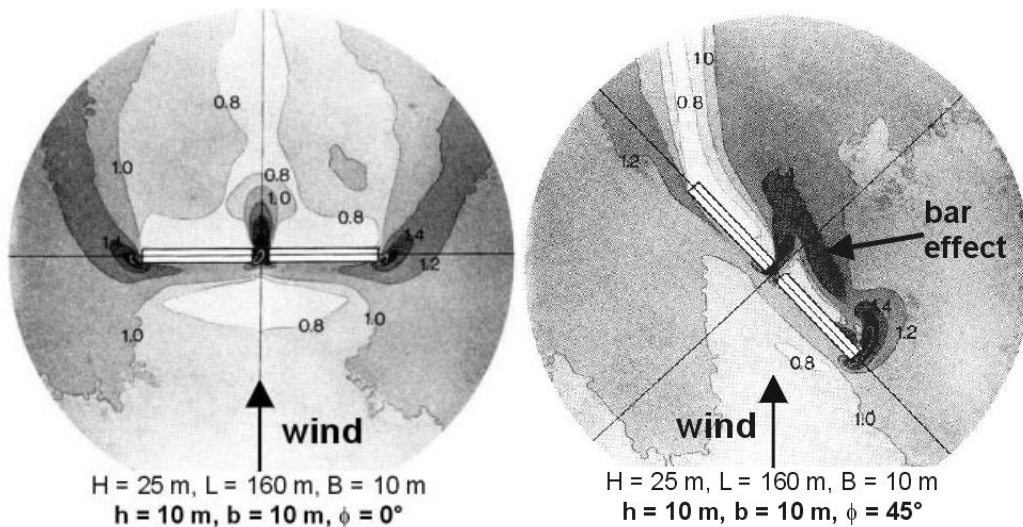

Some of the general flow features are observed: the **stagnation zone** in front of the building and the **corner streams**. The **standing vortex** is hardly visible. A **jet** with increased wind speeds is found in the passage and behind the building. The highest values of amplification factor are just beyond the entrance (up to $AF = 1.8$) but high values are clearly maintained for a considerable distance behind the building. The **corner streams** at the passage corners contribute to and merge into the **passage jet**.

For oblique wind at 45° the jet is situated at the left side of the passage. **Corner streams** are present at the upwind building corner and at the left passage corner. The one at the upwind building corner is more pronounced than that for wind direction 0° . Corners streams for oblique wind are more severe.

Behind the building, the **bar effect** is observed. It typically occurs for buildings (with or without through-passage) of moderate height (15–25 m) when the wind direction is about 45° . A **vortex** is

formed that rolls over the building and that is more or less aligned with the building. It causes increased wind speeds at ground level. In the present case, amplification factors between 1.4 and 1.6 are observed.

Measures to improve the wind climate in passages can be

- (1) the placing of screens in the passage to increase the flow resistance,
- (2) the use of long air-tight tubes ending outside the over- and under-pressure zones to decrease the pressure difference
- (3) the simplest solution: to permanently close the passages.

Through-passages in a building design can often be avoided, the latter solution is generally the best.

PASSAGE BETWEEN PARALLEL BUILDINGS

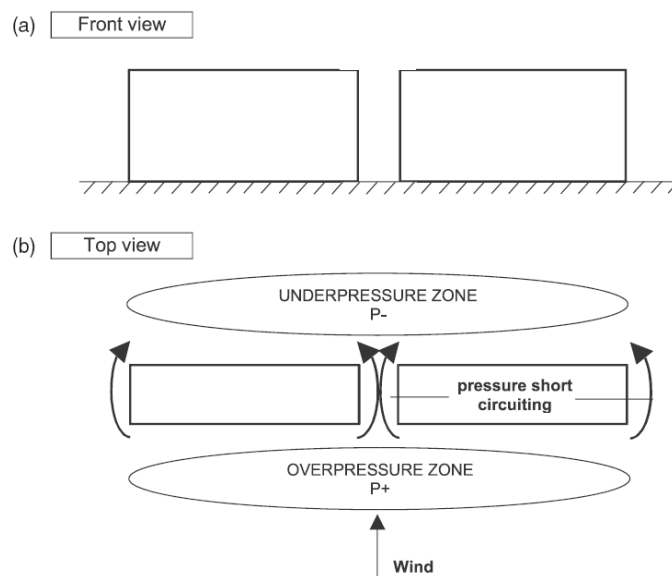

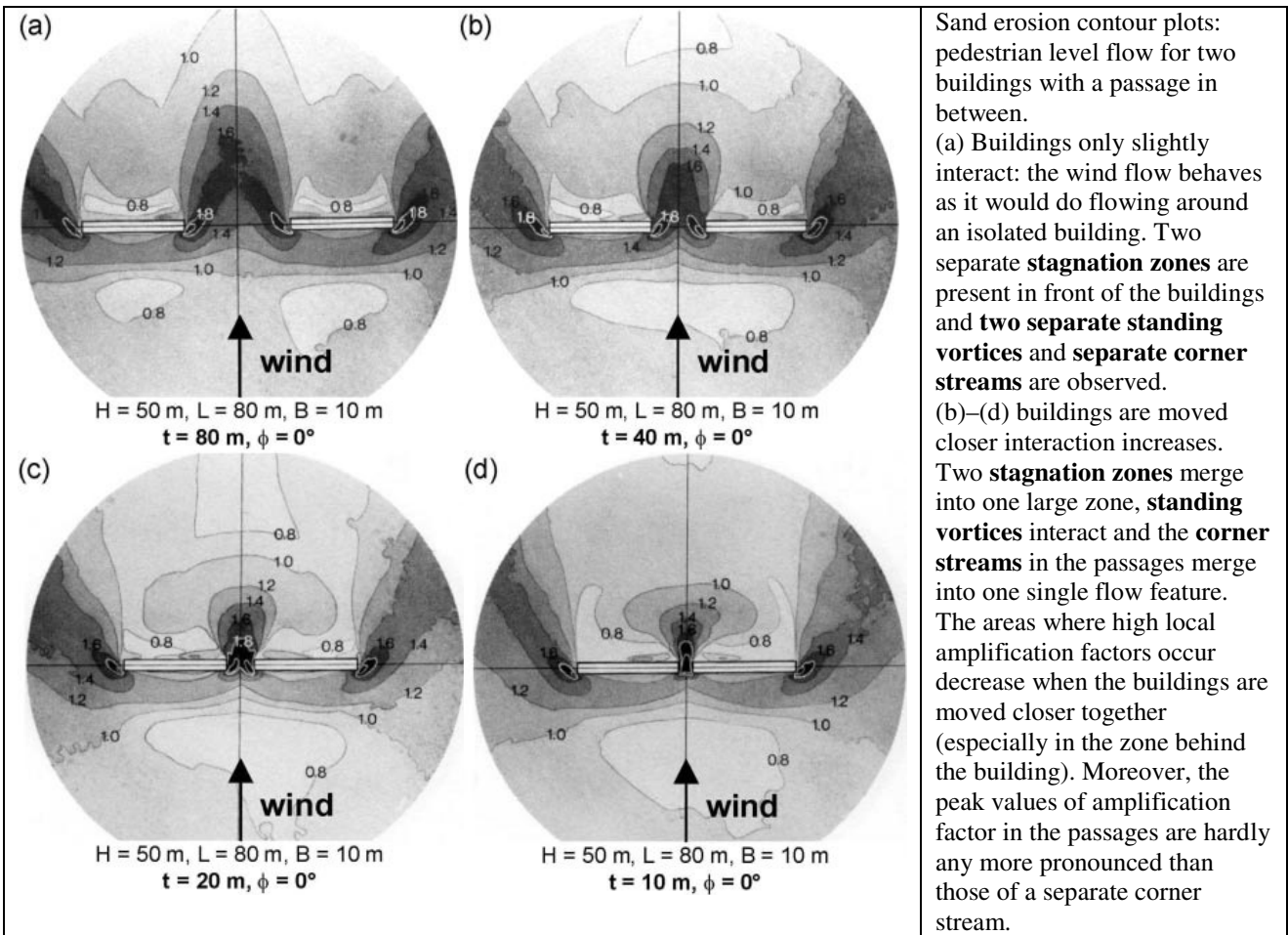

WIND FLOW FOR TWO PARALLEL BUILDINGS SHIFTED TOWARDS EACH OTHER

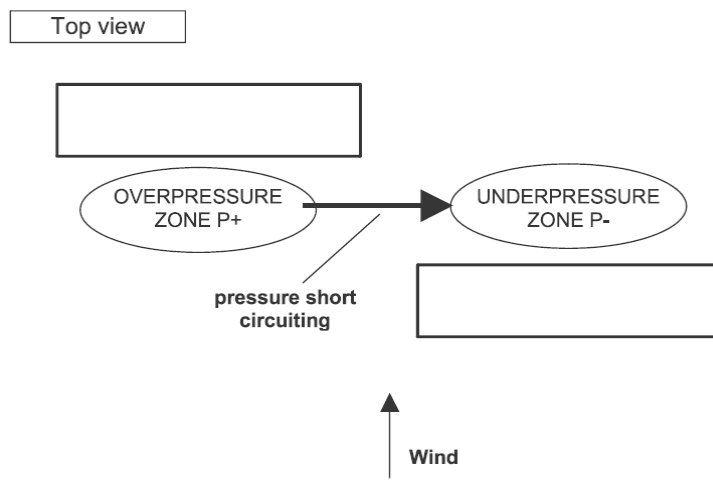

Transverse flow between the buildings is caused by „pressure short-circuiting” between the overpressure zone in front of the windward facade of one building and the underpressure zone behind the leeward facade of the other.

--

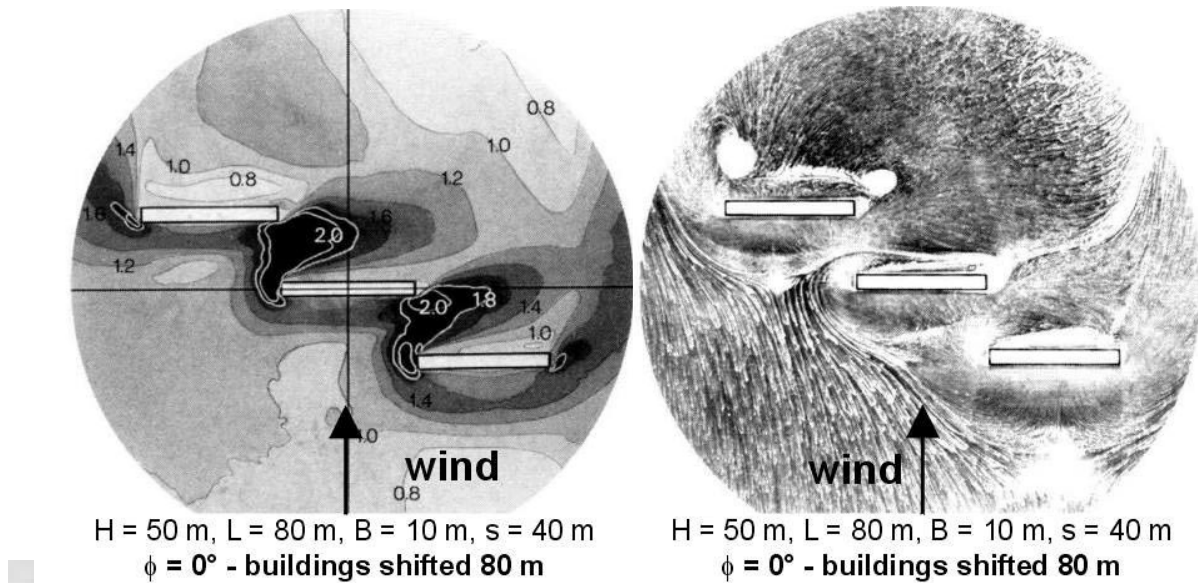

Sand erosion contour plot and kaolin streak line plot.

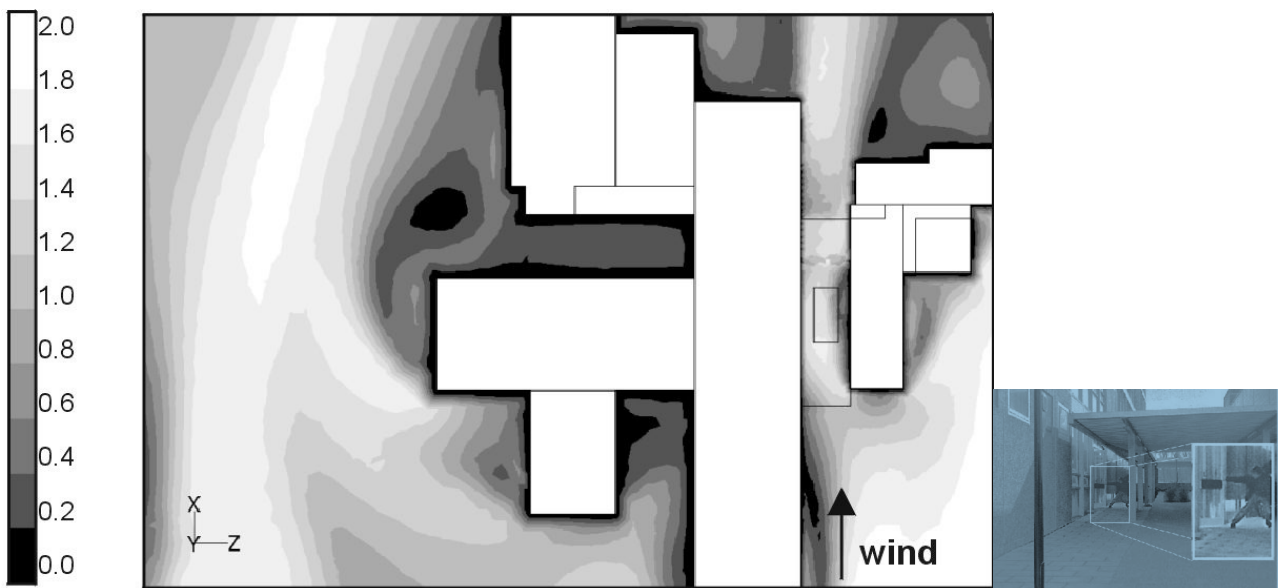

Contours of local amplification factor in a horizontal plane at 1.75m height above ground (pedestrian height).

High wind amplification factors are found in the passage which are in clear contrast to the sheltered regions at the other side of the building.

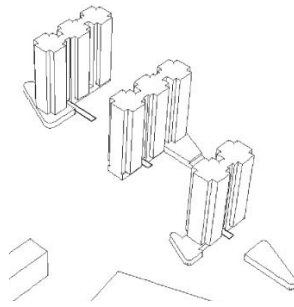

Through-passages and canopies through each of the Silvertop Towers. The building entrances are situated in the passages (public safety by social control: through sight)

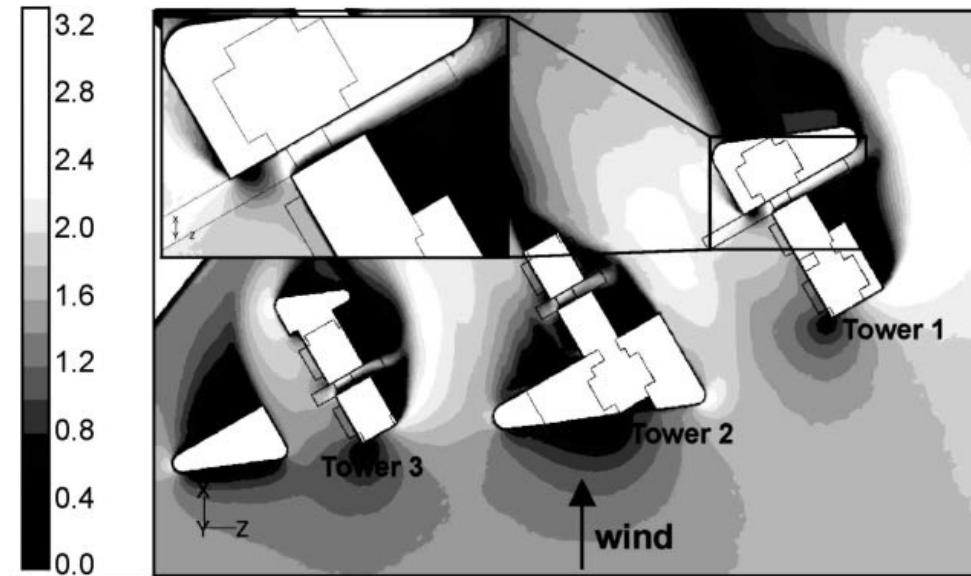

Contours of local amplification factor in pedestrian height. Conditions in the passage through tower 1, where the highest amplification factor up to 3 was found.

Conclusions, recommendations

1. The consequences of an unfavorable pedestrian wind environment near high-rise buildings can hardly be overestimated. High wind speeds can be detrimental to the success of new buildings. They can even be life threatening for the elderly and the infirm. Most building designers are not sufficiently aware of possible wind environmental problems. Numerous examples exist of pedestrian wind nuisance in cities all over the world.
2. Past studies have indicated that for single rectangular high-rise buildings, the corner streams and the frontal vortex are the most important causes for wind nuisance.
3. Doors and passage-ways near buildings corners, passages through buildings and passage-ways that are led through narrow passages between buildings should be avoided because of „pressure short-circuiting” effects.
4. The same holds for shifted buildings.

5. In passages between parallel buildings the wind speed is hardly any more pronounced than the corner stream around a single building corner.

6. There is an important lack of and an increasing demand for experimental data around a large number of building configurations to be used for CFD validation, in particular related to pedestrian wind. This is essential for the future use of CFD in pedestrian wind studies. When using CFD, the best that one can do at this moment is

(a) to conduct wind tunnel experiments oneself for the particular configuration under study

(b) to use the limited quantitative wind tunnel data that is available only for a few configurations

(c) to use the qualitative database of wind tunnel studies

