

Budapesti University of Technology and Economics

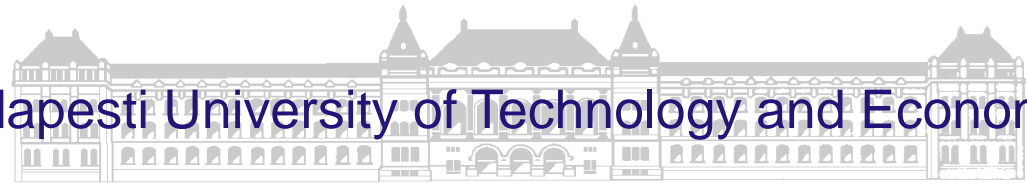

Department of Fluid Mechanics

Pre-measurement class I.

Dr. Csaba Horváth horvath@ara.bme.hu

M1	Füle Péter	fule@ara.bme.hu	M8	Farkas Balázs	farkas@ara.bme.hu
M2	Dr. Balogh Miklós	balogh@ara.bme.hu	M9	Tomor András	tomor@ara.bme.hu
M3	Dr. Istók Balázs	istok@ara.bme.hu	M10	Bak Bendegúz	bak@ara.bme.hu
M4	Varga Árpád	varga@ara.bme.hu	M11	László Nagy	nagy@ara.bme.hu
M5	Dr. Horváth Csaba	horvath@ara.bme.hu	M12	Balla Esztella	balla@ara.bme.hu
M7	Mikó Szandra	miko@ara.bme.hu	M13	Tóth Bence	tothbence@ara.bme.hu

2016.

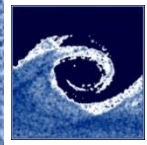

General information

- Department webpage: www.ara.bme.hu
- Student information page: www.ara.bme.hu/poseidon
(materials, test scores, etc.)
- Measurement groups will be assigned.

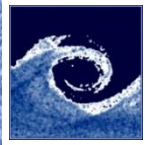

General information

- **Timetable:**

- 1st session: Measurement devices, measurement methods. Introduction to the measurement facilities, measurement uncertainty
- 2nd session: A measurement, B measurement
- 3rd session: Makeup measurements
- 4th session: A+B measurement presentations

(Details can be found in the syllabus)

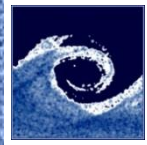

Measuring pressure differences (measuring Δp)

- Provides the basis of many measurements (e.g. velocity, volume flow rate)
- For a fluid medium, pressure differences can be measured between two points
- It is often measured with regard to a reference value (atmospheric pressure, static pressure in a duct)
- Measurement instruments
 - U tube manometer
 - Betz manometer
 - Inclined micro manometer
 - Bent tube micro manometer
 - EMB-001 digital handheld manometer

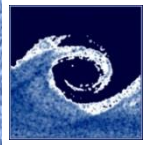

Measuring Δp / U tube manometer I.

- Pipe flow
- Butterfly valve
- Average of the pressure measured on the pressure taps around the perimeter

The manometers balance equation:

$$p_L = p_R$$

$$p_1 + \rho_{ny} \cdot g \cdot H = p_2 + \rho_{ny} \cdot g \cdot (H - \Delta h) + \rho_m \cdot g \cdot \Delta h$$

$$p_1 - p_2 = (\rho_m - \rho_{ny}) \cdot g \cdot \Delta h$$

Can be simplified if

$$\rho_{ny} \ll \rho_m$$

(e.g. if the measured fluid is air

and the measurement fluid is water)

$$p_1 - p_2 = \rho_m \cdot g \cdot \Delta h$$

Notice that

$$\Delta p \neq f(H)$$

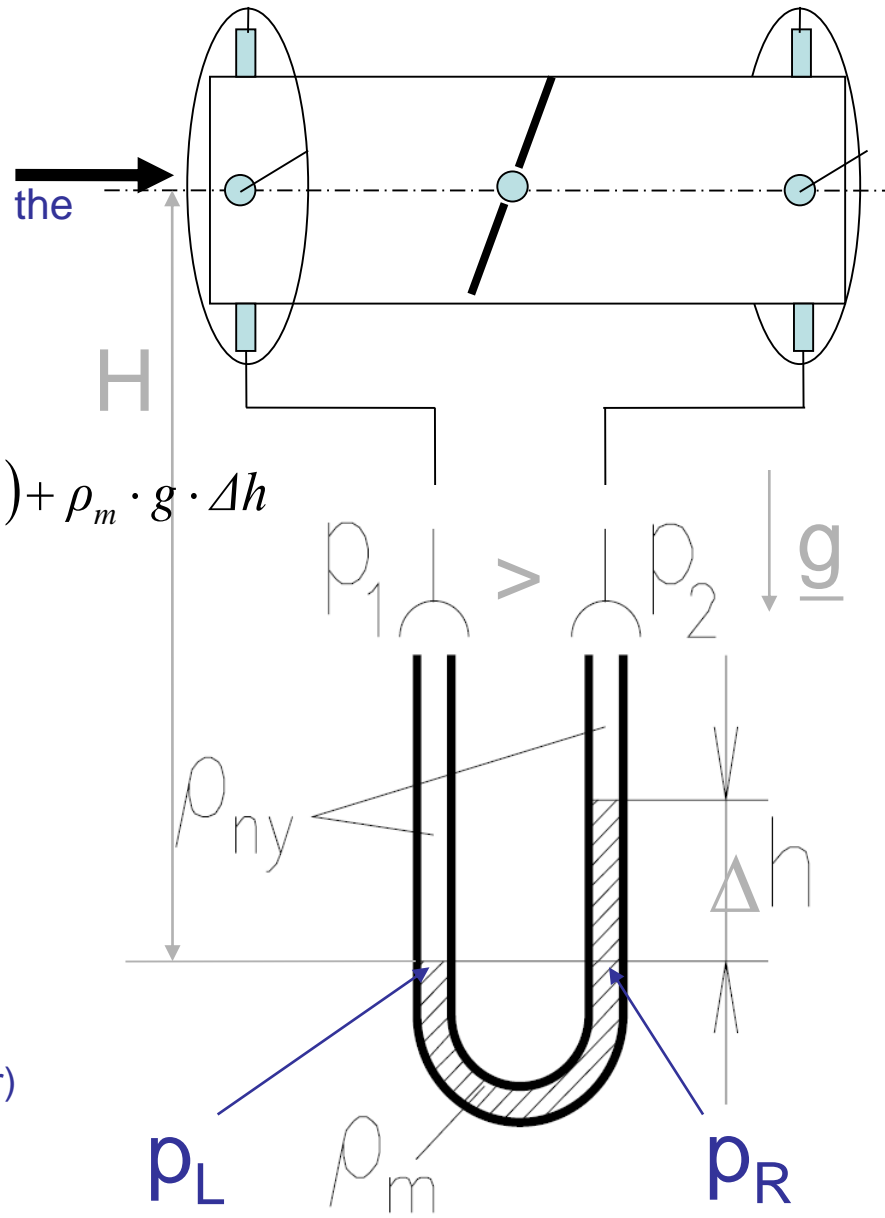

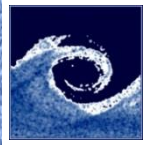

Measuring Δp / U tube manometer II.

The manometers balance equation:

$$\Delta p = (\rho_m - \rho_{ny})g\Delta h$$

Density of the measuring fluid ρ_m (approximately)

$$\rho_{Hg} \approx 13600 \frac{kg}{m^3} \quad \text{mercury}$$

$$\rho_{water} \approx 1000 \frac{kg}{m^3} \quad \text{water}$$

$$\rho_{Alcohol} = 830 \frac{kg}{m^3} \quad \text{alcohol}$$

Density of the measured fluid: ρ_{ny} (For example air)

$$\rho_{air} = \frac{p_0}{R \cdot T} = 1.19 \frac{kg}{m^3}$$

p_0 - atmospheric pressure [Pa] $\sim 10^5$ Pa

R - specific gas constant for air 287[J/kg/K]

T - atmospheric temperature [K] ~ 293 K=20°C

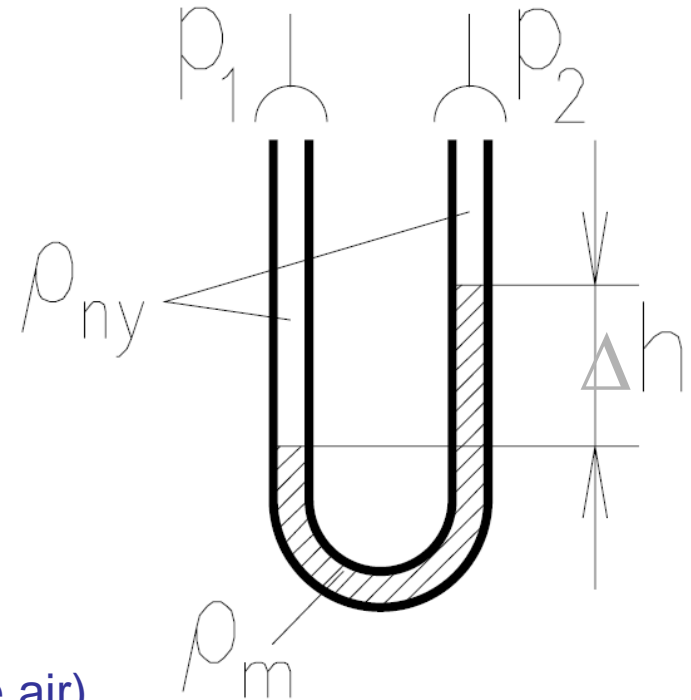

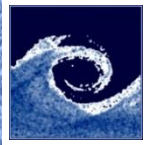

Measuring Δp / U tube manometer III.

Example: the reading: $\Delta h = 10mm$

The accuracy $\sim 1mm$: The absolute error:

$$\delta(\Delta h) = \pm 1mm$$

How to write the correct value with the absolute error(!)

$$\Delta h = 10mm \pm 1mm$$

The relative error:

$$\frac{\delta(\Delta h)}{\Delta h} = \frac{1mm}{10mm} = 0.1 = 10\%$$

Disadvantages:

- Reading error (take every measurement twice)
- Accuracy $\sim 1mm$
- For a small pressure difference, the relative error is large

Advantages:

- Reliable
- Does not require servicing

Measuring Δp / upside down U tube micro manometer

The manometer's balance equation

$$p_1 - p_2 = (\rho_v - \rho_l) \cdot g \cdot h$$

Since in most cases upside down U tube manometers are used to measure liquid (e.g. water) filled lines, the measurement fluid is usually air, and the density ratio is therefore (1.2/1000). $-\rho_l$ (density of air) can be neglected.

The advantage of this measuring device is that when it is used for liquid filled systems, air can be used instead of mercury in order to improve the accuracy of the relative error of the readings!

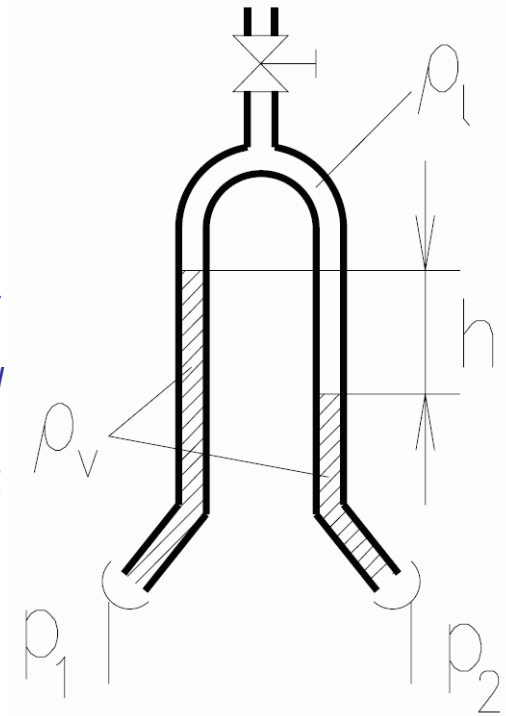

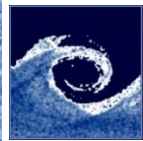

Measuring Δp / Betz micro manometer

The relative error is reduced by optical means, improving the accuracy.

Accuracy $\sim 0,1\text{mm}$: The absolute error is:

$$\Delta h = 10\text{mm} \pm 0.1\text{mm}$$

The relative error:

$$\frac{\delta(\Delta h)}{\Delta h} = \frac{0.1\text{mm}}{10\text{mm}} = 0.01 = 1\%$$

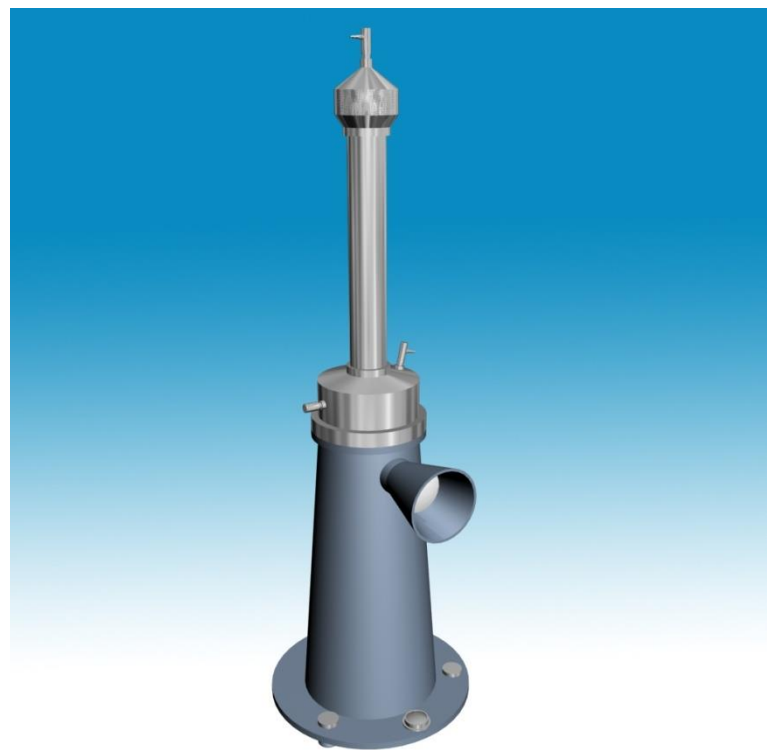
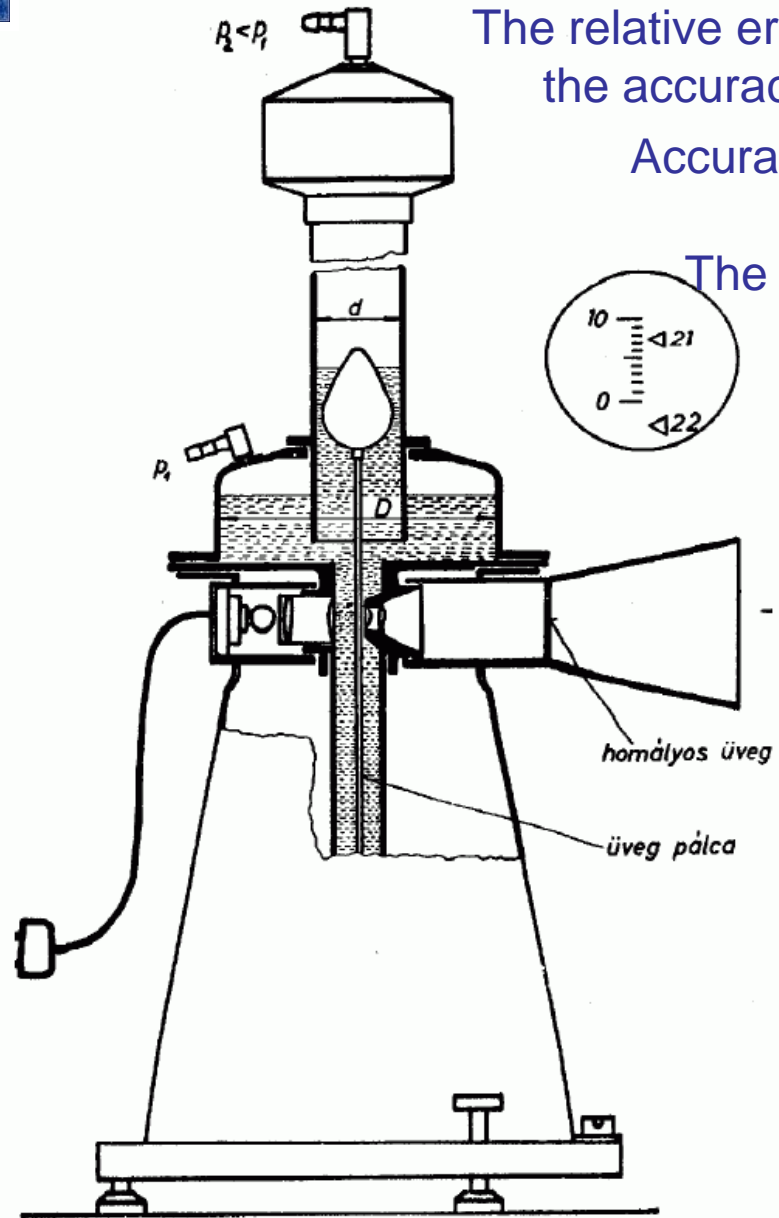

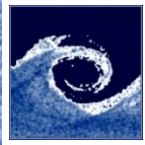

Measuring Δp / inclined micro manometer

The manometers balance equation

$$p_1 - p_2 = \rho_m \cdot g \cdot \Delta h$$

$$\Delta h = L \cdot \sin\alpha$$

Accuracy: $\delta L \sim \pm 1\text{mm}$,

Relativ error in the case of $\alpha=30^\circ$

$$\frac{\delta L}{L} = \frac{\delta L}{\frac{\Delta h}{\sin\alpha}} = \frac{1\text{mm}}{\frac{10\text{mm}}{\sin 30^\circ}} = 0.05 = 5\%$$

The relative error is a function of the inclination angle - $f(\alpha)$ - It is characterized by a changing relative error.

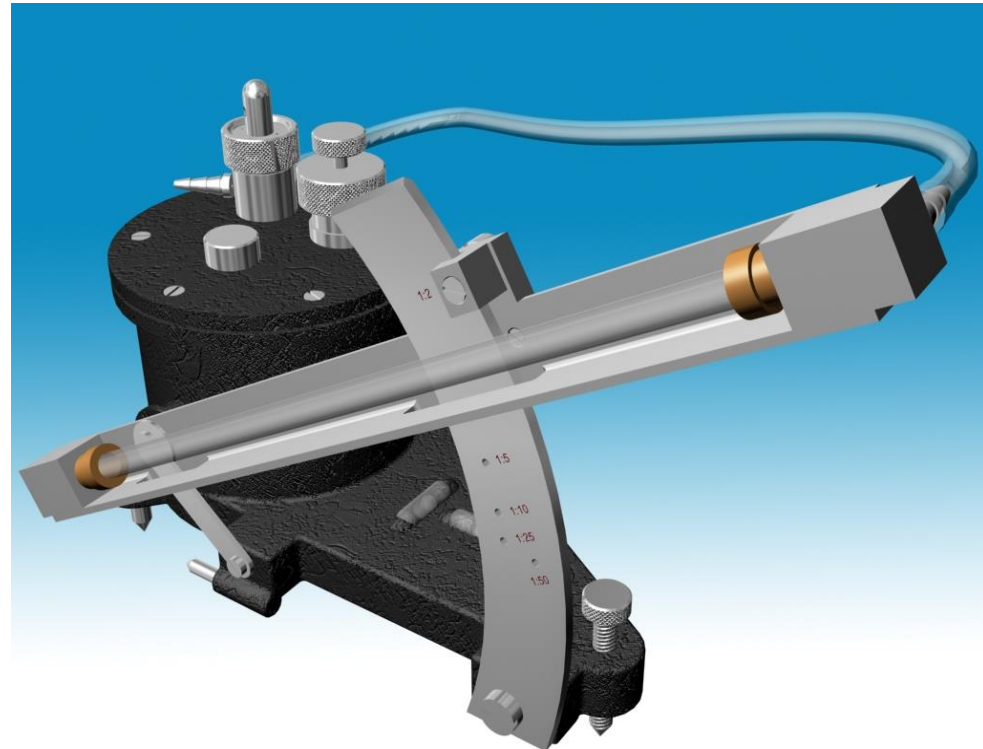
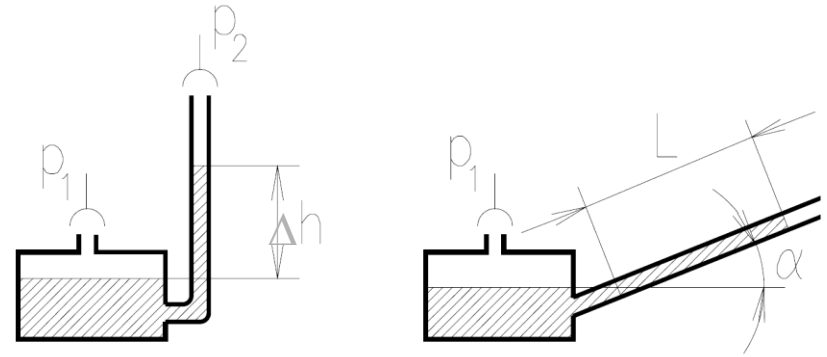

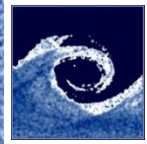

Measuring Δp / bent tube micro manometer

Is characterized by a
constant relative error
and a nonlinear scale

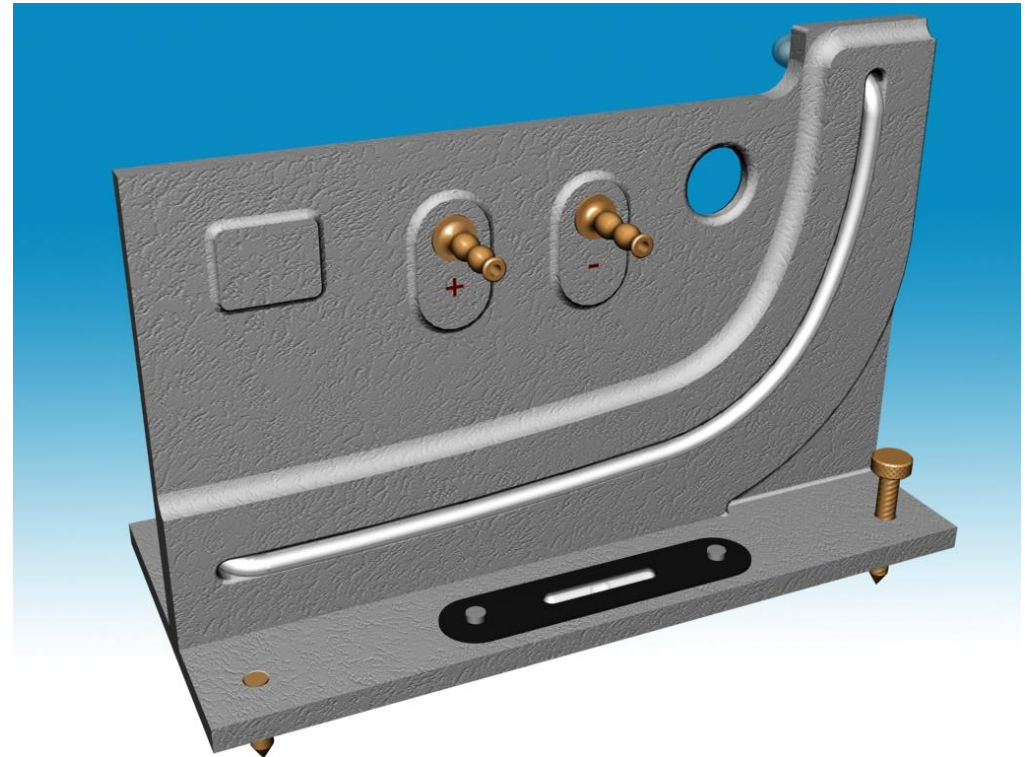
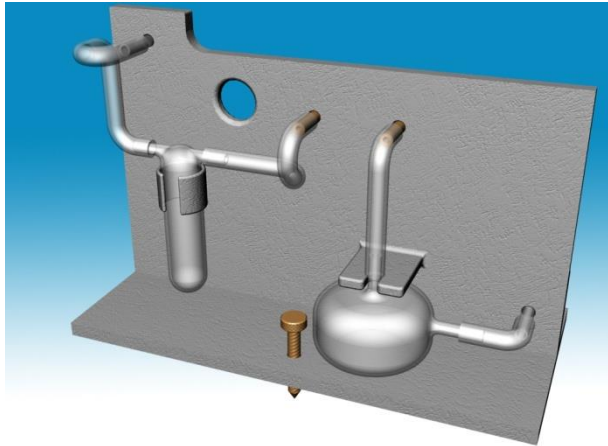

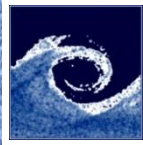

Measuring Δp / EMB-001 digital manometer

List of buttons to be used during the measurements

On/Off	Green button
Factory reset	„0” followed by the „STR Nr
Changing the channel	„CH I/II”
Setting 0 Pa	„0 Pa”
Averaging time(1/3/15s)	„Fast/Slow” (F/M/S)

Measurement range:

$$\Delta p = \pm 1250 Pa$$

Measurement error:

$$\delta \Delta p = 2 Pa$$

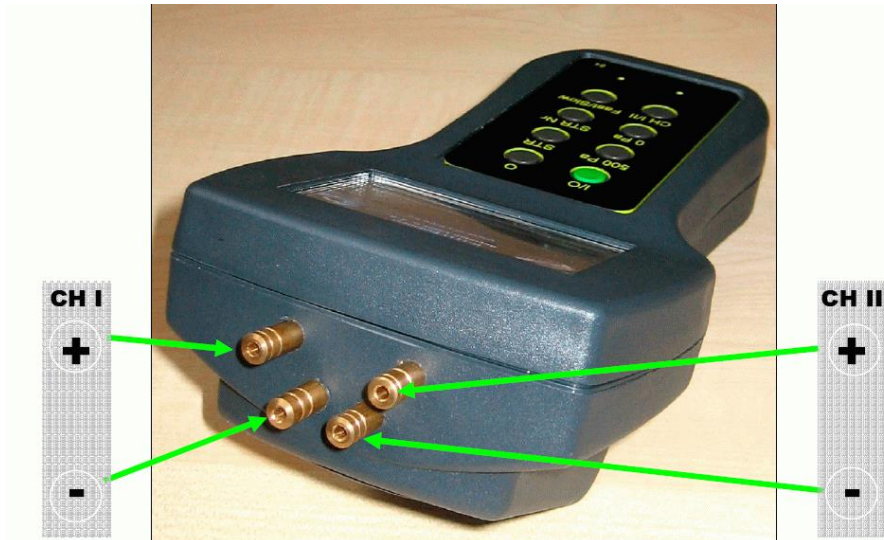

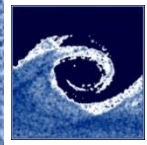

Measuring Δp / EMB-001 digital manometer

During the course of the laboratory sessions, the digital manometers need to be calibrated to the Betz manometers.

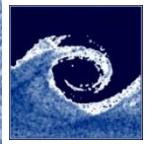

Measuring Δp / Pressure tap

When measuring pressures we need the streamlines to be parallel and straight

In this case the pressure is not changing perpendicularly to the streamlines

(The normal component of the Euler equation)

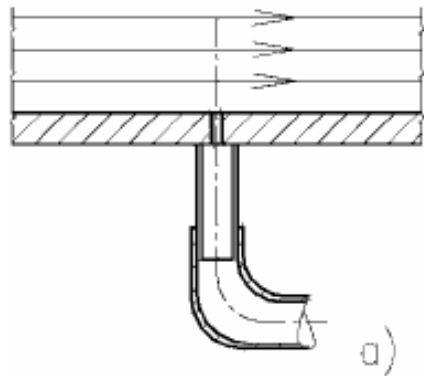

a)

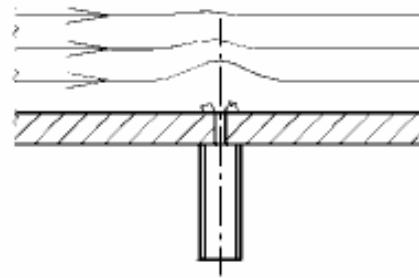

b)

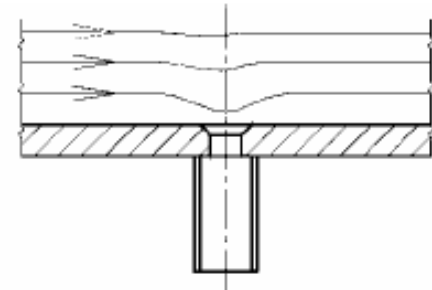

c)

a) Correct b) c) Incorrect

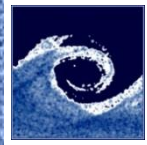

Velocity measurement devices

- Pitot tube/probe
- Pitot-static (Prandtl) tube/ probe

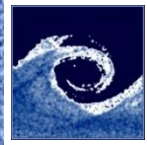

Velocity measurement / Pitot tube/probe

Pitot, Henri (1695-1771), French engineer.

Determining the dynamic pressure:

$$p_d = p_t - p_{st}$$

p_t the pressure measured in the stopped fluid (total pressure)

p_{st} the pressure acting on a surface which is parallel to the flow (static pressure)

$$p_d = \frac{\rho_{ny}}{2} \cdot v^2$$

Determining the velocity:

$$v = \sqrt{\frac{2}{\rho_{ny}} \cdot p_d}$$

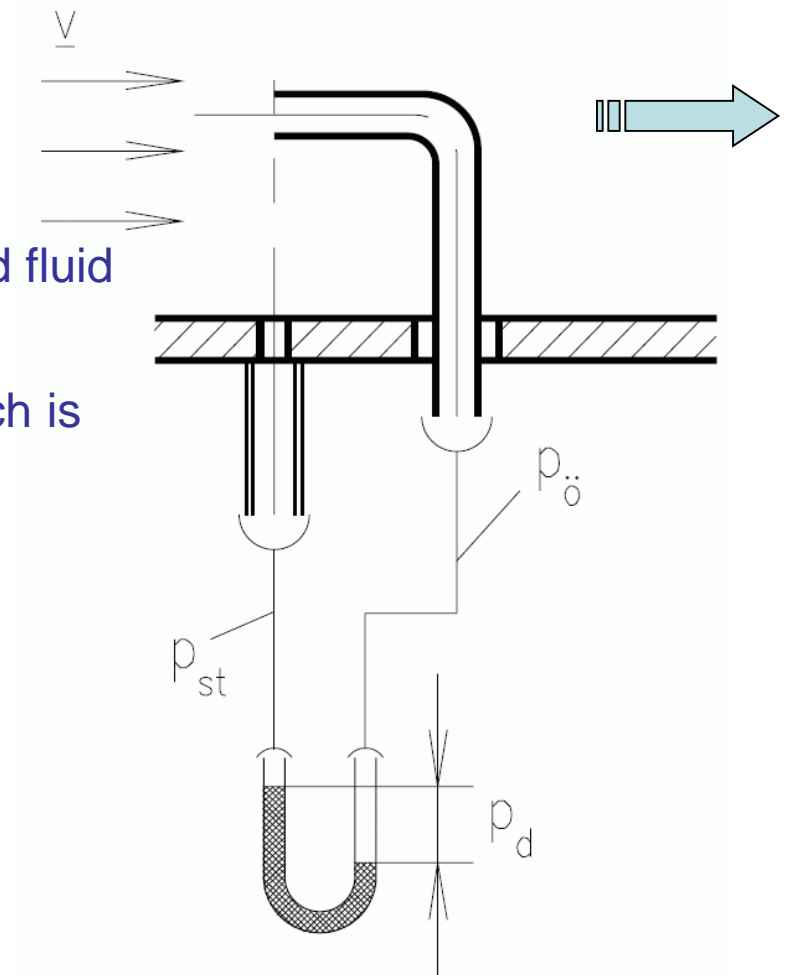

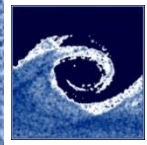

Velocity measurement / Pitot-static (Prandtl) tube/probe

Prandtl, Ludwig von (1875-1953), German fluid mechanics researcher

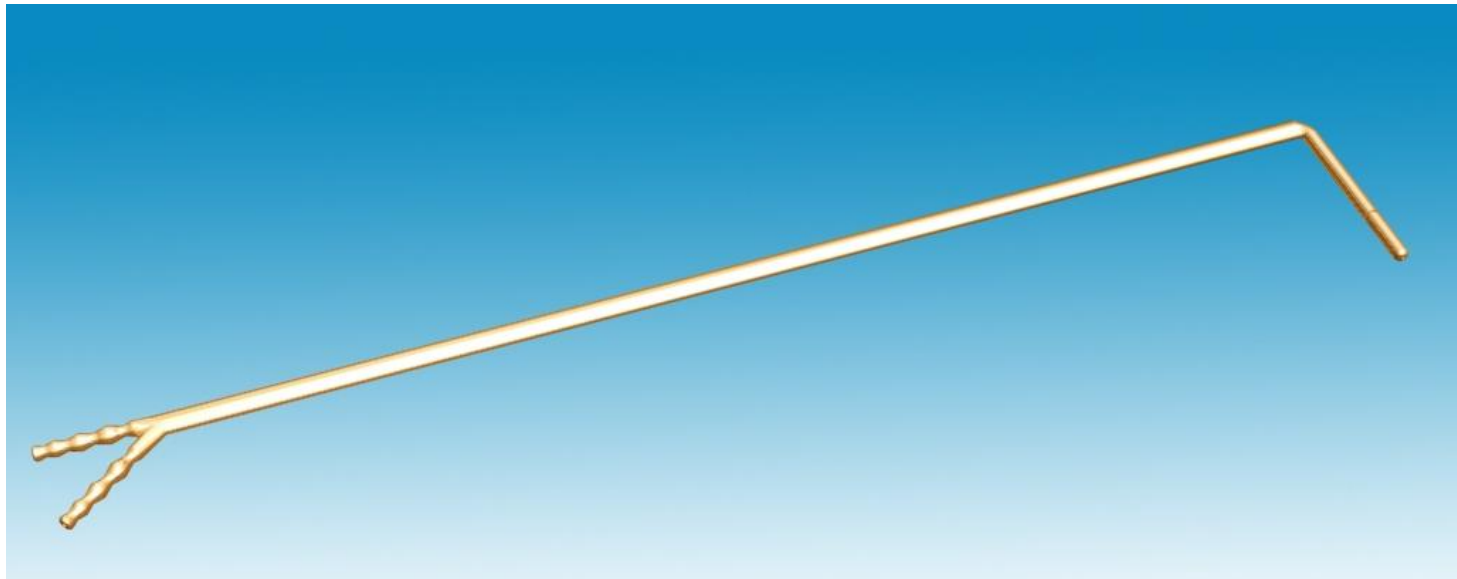
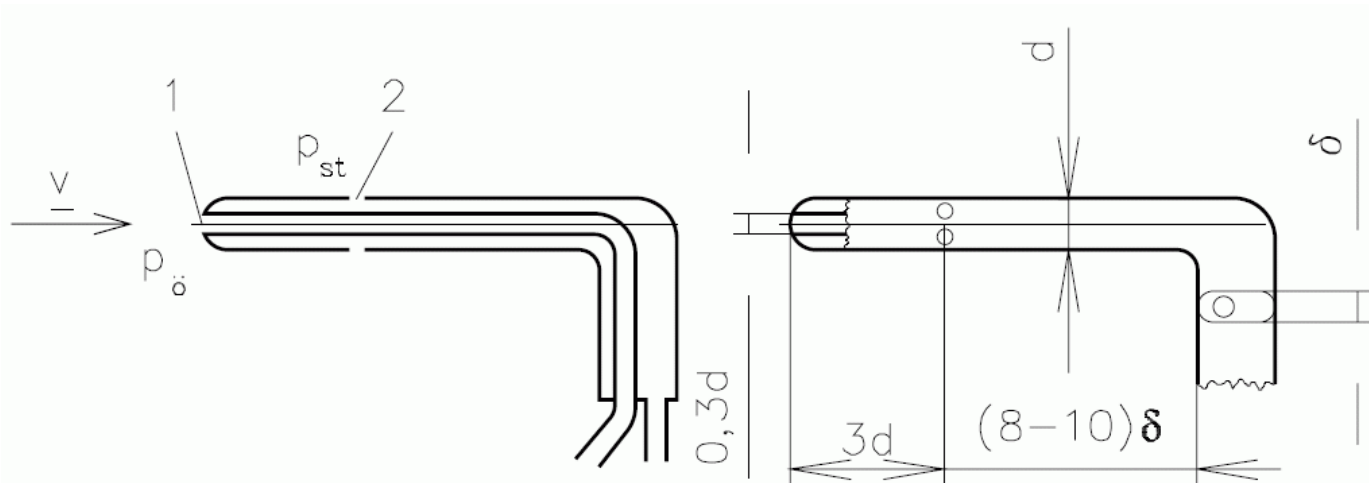

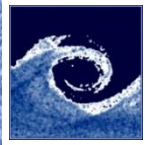

Measuring volume flow rate

- Definition of volume flow rate
- Measurement method based on velocity measurements in multiple points
 - Non-circular cross-sections
 - Circular cross-sections
 - 10 point method
 - 6 point method
- Pipe flow meters based on flow contraction
 - Venturi flow meter (horizontal/inclined axis)
 - Through flow orifice (contraction ratio, iteration)
 - Inlet orifice
 - Inlet bell mouth

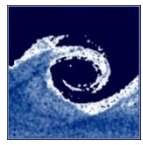

Calculating an average velocity from multiple velocity measurements

Very important: the square root of the averages \neq the average of the square roots(!)

Example: Measuring the dynamic pressure in multiple points and calculating the velocity from it

$$v_i = \sqrt{\frac{2}{\rho_{ny}} \cdot \Delta p_i}$$

$$v_1 = \sqrt{\frac{2}{\rho_{ny}} \cdot \Delta p_1}$$

1.	2.
3.	4.

$$\bar{v} = \frac{\sqrt{\frac{2}{\rho_{ny}} \cdot \Delta p_1} + \sqrt{\frac{2}{\rho_{ny}} \cdot \Delta p_2} + \sqrt{\frac{2}{\rho_{ny}} \cdot \Delta p_3} + \sqrt{\frac{2}{\rho_{ny}} \cdot \Delta p_4}}{4} \neq \sqrt{\frac{2}{\rho_{ny}} \cdot \frac{\Delta p_1 + \Delta p_2 + \Delta p_3 + \Delta p_4}{4}}$$

Correct

Incorrect

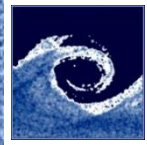

Volume flow rate / based on velocity measurements I.

Non-circular cross-sections

$$q_v = \int_A \underline{v} \cdot \underline{dA} \approx \sum_{i=1}^n v_{m,i} \cdot \Delta A_i$$

Assumptions:

$$\Delta A_1 = \Delta A_2 = \Delta A_i = \frac{A}{n}$$

$$q_v = \Delta A_i \cdot \sum_{i=1}^n v_{m,i} = \frac{A}{n} \cdot \sum_{i=1}^n v_{m,i} = A \cdot \bar{v}$$

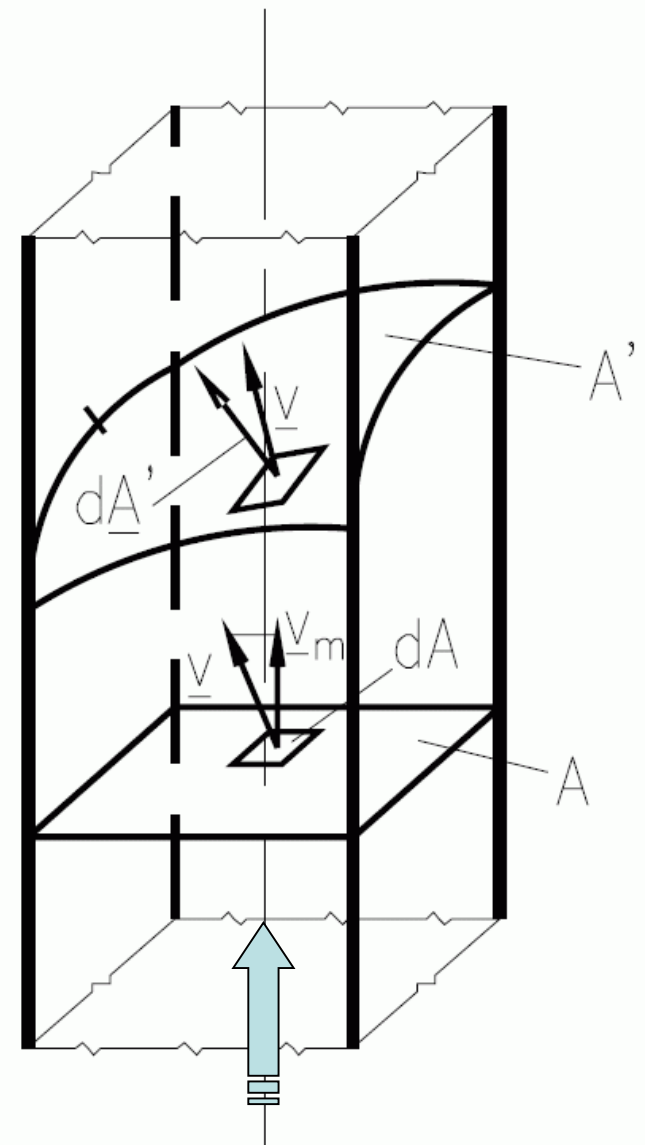
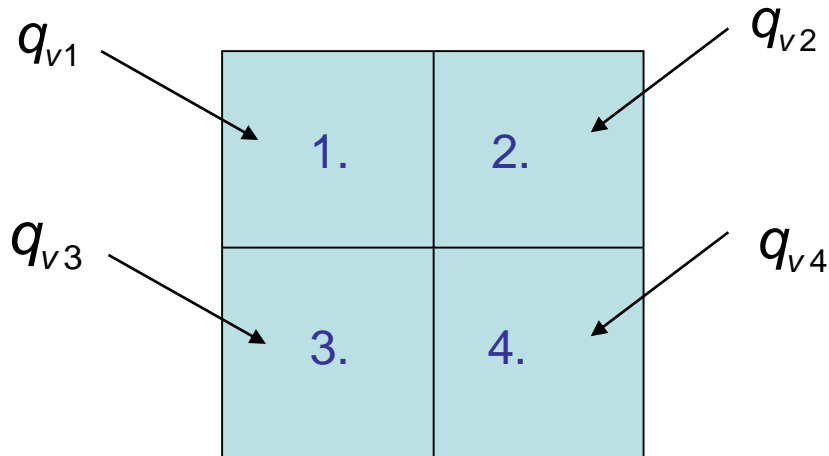

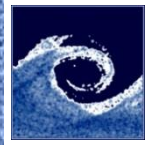

Volume flow rate / based on velocity measurements II.

Circular cross-sections, 10 point (6 point) method

- The velocity profile is assumed to be a 2nd order parabola
- Steady flow conditions
- Based on Pitot-static (Prandtl) tube measurements of the dynamic pressure

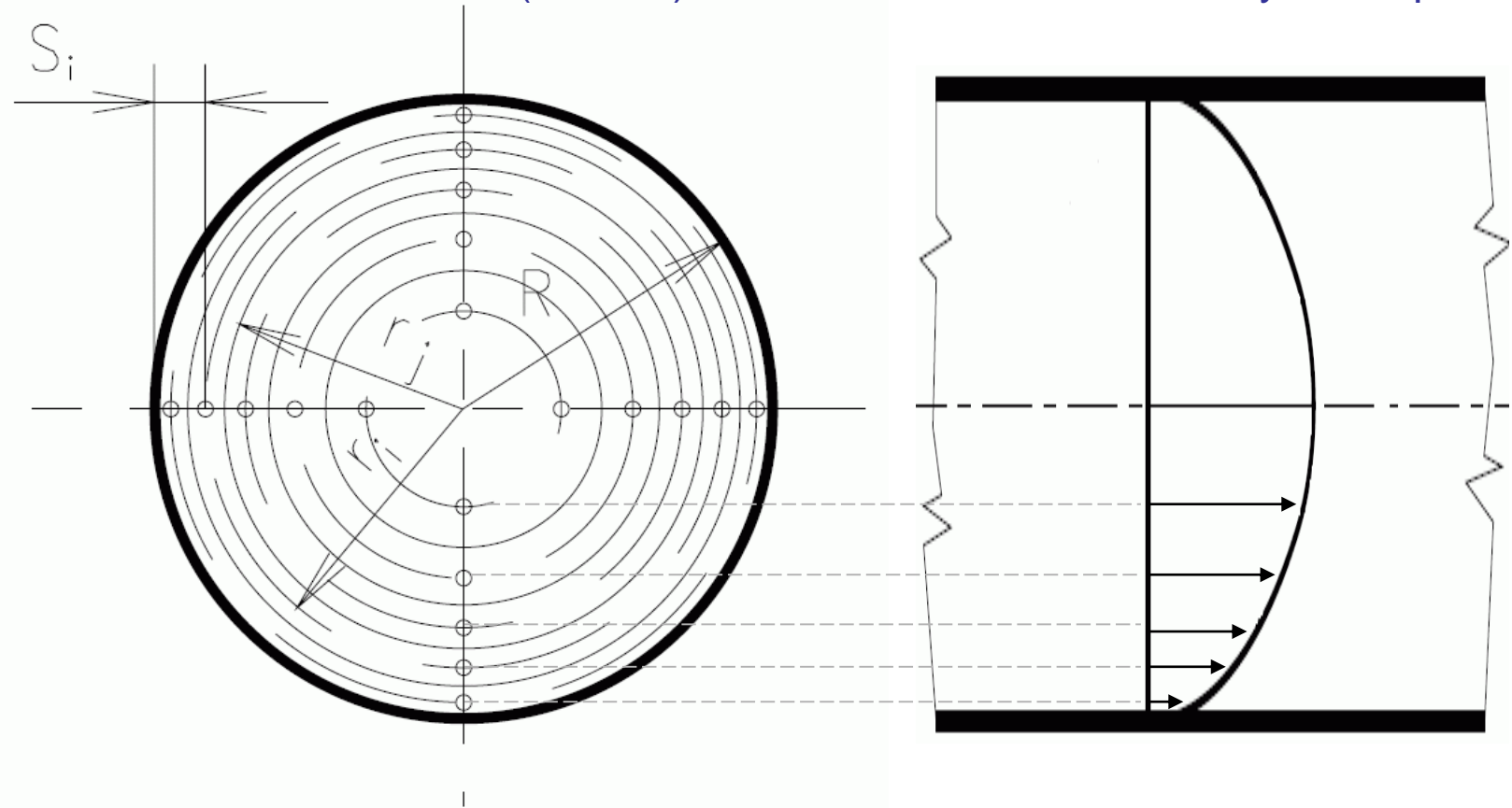

This is a standardized procedure, and the measurement point are given in the standard (MSZ 21853/2):

$S_i/D = 0.026, 0.082, 0.146, 0.226, 0.342, 0.658, 0.774, 0.854, 0.918, 0.974$

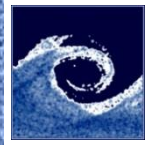

Volume flow rate / based on velocity measurements III. Circular cross-sections, 10 point (6 point) method

$$q_v = A \cdot \frac{v_1 + v_2 + \dots + v_{10}}{10}$$

Assumptions:

$$A_1 = A_2 = \dots = A_{10}$$

The **advantage** of this method, as compared to methods based on flow contraction, is that the flow is not disturbed greatly, and therefore the operation point of the system is not altered, and it is easy to execute the measurements.

The **disadvantage** is that the error can be much larger with this method. For long measurements it is also hard to keep the flow conditions constant. (10 points x 1.5 minutes = 15 minutes)

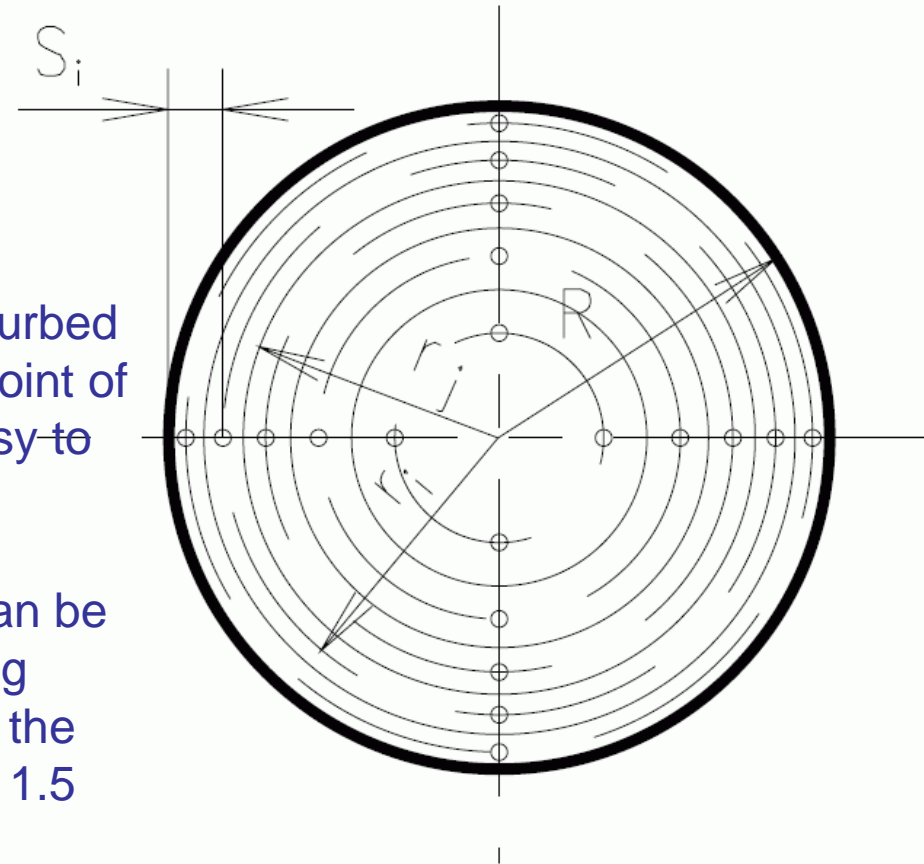

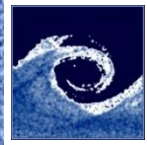

Volume flow rate / flow contraction methods

Venturi pipe

If compressibility is negligible
($\rho = \text{constant}$):

$$q_v = v \cdot A = \text{const.} \quad [q_v] = \frac{m^3}{s}$$

$$q_v = v_1 \cdot A_1 = v_2 \cdot A_2$$

Bernoulli equation
($\rho = \text{const.}$, $U = \text{const.}$, no losses):

$$p_1 + v_1^2 \cdot \frac{\rho_{ny}}{2} = p_2 + v_2^2 \cdot \frac{\rho_{ny}}{2}$$

$$v_1 = \sqrt{\frac{(\rho_m - \rho_{ny}) \cdot g \cdot \Delta h}{\frac{\rho_{ny}}{2} \cdot \left[\left(\frac{d_1}{d_2} \right)^4 - 1 \right]}} = \sqrt{\frac{\Delta p}{\frac{\rho_{ny}}{2} \cdot \left[\left(\frac{d_1}{d_2} \right)^4 - 1 \right]}}$$

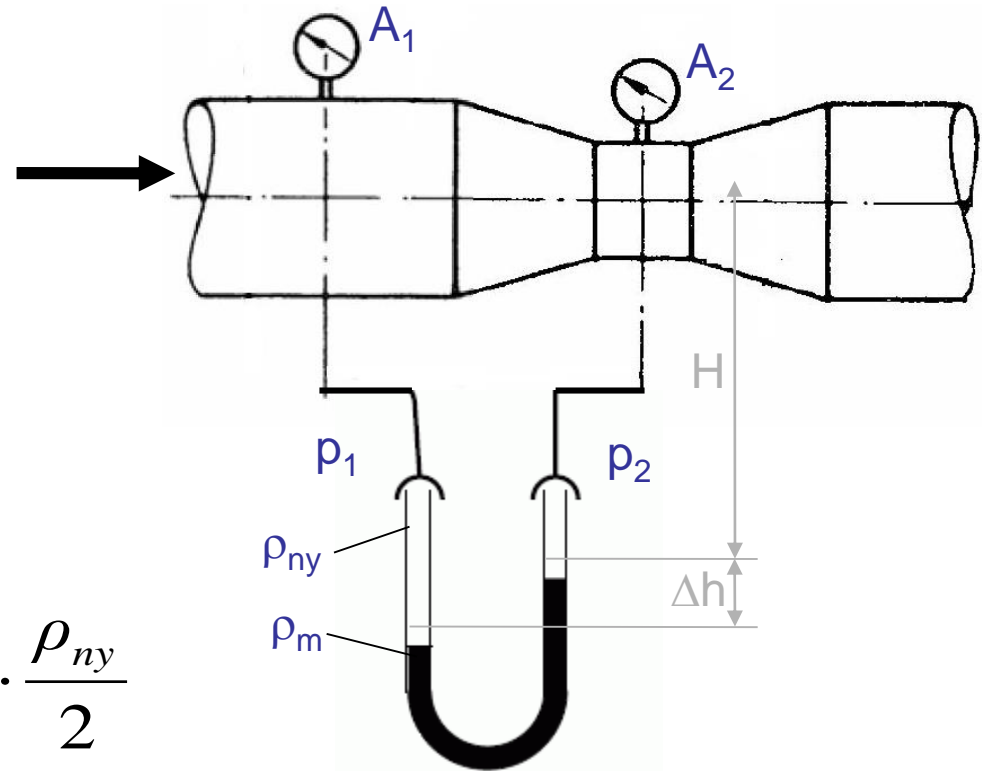

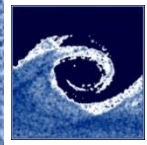

Volume flow rate / flow contraction methods

Through flow orifice

Standard orifice - pressure difference

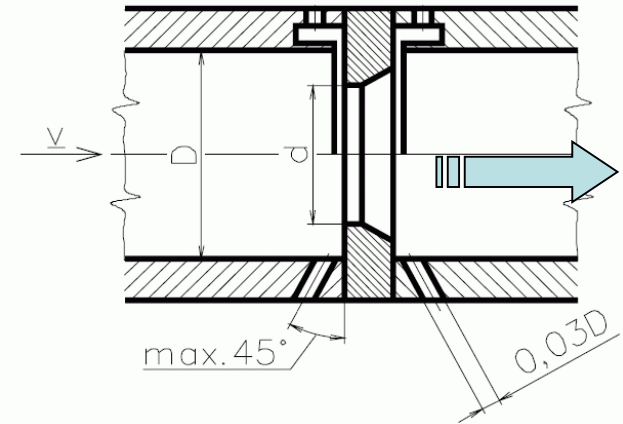
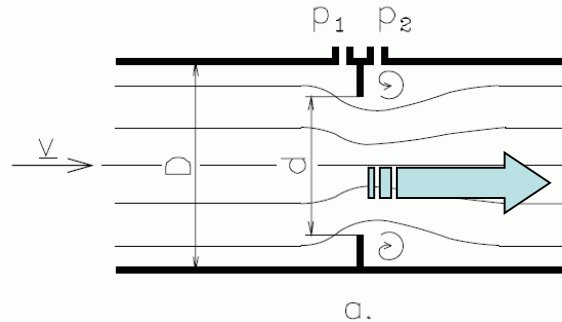

$$q_v = \alpha \cdot \varepsilon \cdot \frac{d_{or}^2 \cdot \pi}{4} \cdot \sqrt{\frac{2\Delta p_{or}}{\rho}}$$

- $\beta = d/D$ Cross-section ratio
- d [m] Diameter of the smallest cross-section
- D [m] Diameter of the pipe upstream of the orifice
- $Re_D = Dv/\nu$ Reynolds number's basic equation
- v [m/s] The average velocity in the pipe of diameter D
- ν [m²/s] kinematic viscosity
- p_1 [Pa] The pressure measured upstream of the orifice
- p_2 [Pa] The pressure measured downstream of the orifice
- ε Expansion number ($\varepsilon = \varepsilon(\beta, \tau, \kappa) \sim 1$ since for air, the change in pressure is small)
- α Contraction ratio, $\alpha = (\beta, Re)$ (When used according to the standard)
- κ Heat capacity ratio or Isentropic expansion factor
- $\tau = p_2/p_1$ Pressure ratio

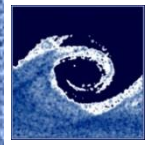

Volume flow rate / flow contraction methods Inlet orifice (not standard)

Not a standard contraction – pressure difference

$$q_v = \alpha \cdot \varepsilon \cdot \frac{d_{or}^2 \cdot \pi}{4} \cdot \sqrt{\frac{2\Delta p_{or}}{\rho}}$$

$$\alpha = 0.6$$

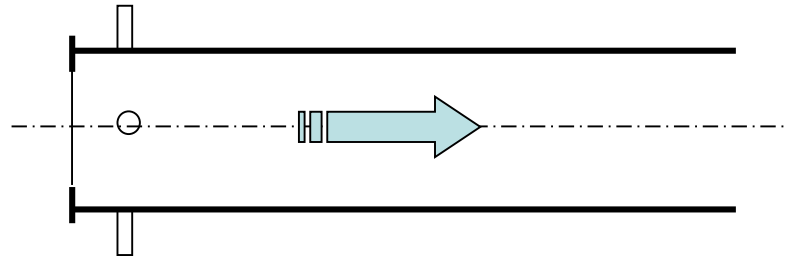

$$q_v = k \cdot \frac{d_{or}^2 \cdot \pi}{4} \cdot \sqrt{\frac{2\Delta p_{or}}{\rho}}$$

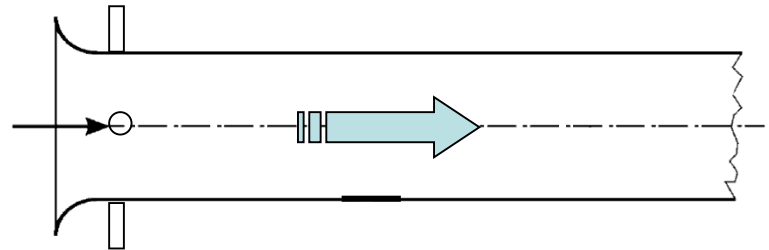

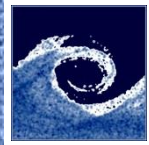

Downloadable material

<http://www.ara.bme.hu/oktatas/tantargy/NEPTUN/BMEGEATAM06/20xx-20xx-N/lab-laboratory/>

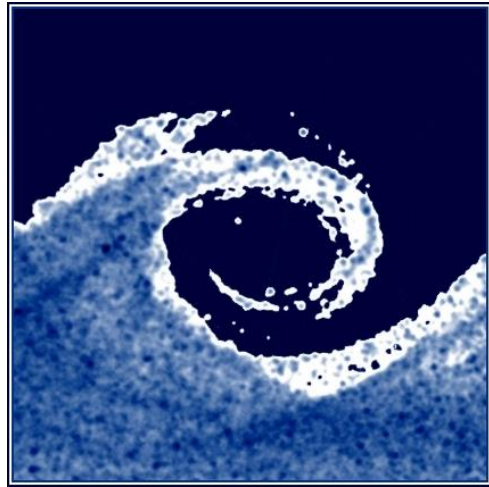

Budapesti University of Technology and Economics

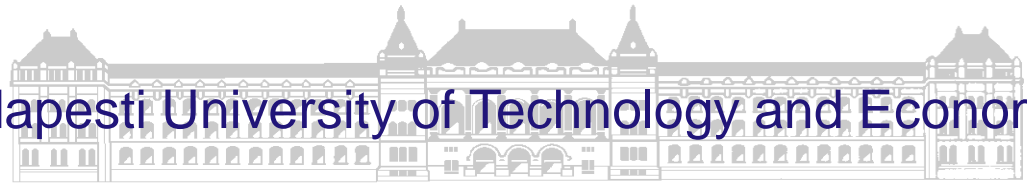

Department of Fluid Mechanics

Pre-measurement class II.

Dr. Csaba Horváth horvath@ara.bme.hu

M1 Füle Péter fule@ara.bme.hu

M2 Dr. Balogh Miklós baloghm@ara.bme.hu

M3 Dr. Istók Balázs istok@ara.bme.hu

M4 Varga Árpád varga@ara.bme.hu

M5 Dr. Horváth Csaba horvath@ara.bme.hu

M7 Mikó Szandra miko@ara.bme.hu

M8 Farkas Balázs farkas@ara.bme.hu

M9 Tomor András tomor@ara.bme.hu

M10 Bak Bendegúz bak@ara.bme.hu

M11 László Nagy nagy@ara.bme.hu

M12 Balla Esztella balla@ara.bme.hu

M13 Tóth Bence tothbence@ara.bme.hu

2016.

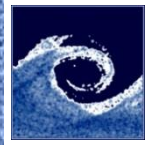

Downloadable materials

www.ara.bme.hu/poseidon

english

login ->username: neptun code (lower case letters), password: NEPTUN
CODE (capital letters)

„Egyéb tantárgyinformációk”

BMEGEATAG11 (or AM06) ->english

Or www.ara.bme.hu

In english

Download

„Tantárgyak”

BMEGEATAG11 (or AM06) ->english

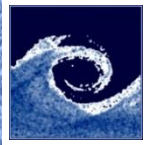

Preparing for the laboratory measurements

- The poseidon network needs to be checked, in order to find out which measurement assignment is given to the group (e.g. M03/c).
- In preparing for the laboratory measurements, all members of the measurement group must read and understand the measurement which is to be made.
- A hand written outline of the measurement needs to be prepared by the lab leader. This outline should contain the following:
 - The measurement groups information (names, neptun codes), leaving a space for checking attendance
 - Space where the measurement supervisor can sign each page.
 - A list of the instruments which will be used during the measurement, leaving room for the serial numbers, which will be documented during the measurement
 - Tables for documenting the measured and calculated values, including atmospheric conditions (e.g. atmospheric pressure and temperature, etc.)
 - The equations which are necessary in order to complete the measurement and the associated calculations, leaving room for verification calculations.

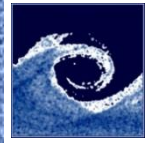

Preparing for the laboratory measurements

- Millimeter paper needs to be brought to the laboratory measurements

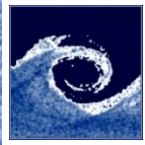

During the laboratory measurement

- At the beginning of the laboratory the hand written outline will be checked by the instructor supervising the measurement, and questions will be asked in order to determine whether the group is prepared for the measurement.
 - If the group is unprepared, they will be sent away
- During the laboratory the faculty member supervising the laboratory session will evaluate the groups preparedness by asking questions regarding the measurement and evaluating the properness of the measurement by conducting sample calculations with the groups as well as having them graph certain values. If the group is deemed unprepared, they will be sent away.
- The measurements need to be completed during the allotted time.
- The proper calibration of the digital manometer needs to be assessed during the laboratory measurement, with the help of the Betz micro manometer.
- During the measurement, department personnel supervising the measurements will assign a task to each group, by which some values measured during the laboratory measurement will be drawn on the millimeter paper, in order to check the correctness of the measurement and the understanding of the measured results. If the task can not be completed in a satisfactory manner, the measurements must be repeated.

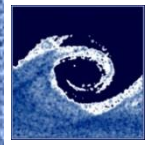

After the laboratory measurement

- A measurement report must be produced from the measured data
- Laboratory calculations must be checked utilizing the departments online evaluation tools.

www.ara.bme.hu/lab

- **Use of the control tools is mandatory.** The control tools only evaluate whether the equations were applied properly.
- **If the calculations were deemed invalid,** they must be repeated.
 - There is no limit as to the number of attempts which can be made, but the attempts are logged, and can be taken into account when giving grades. (fair use policy)
 - In previous semesters each measurement had students who were able to complete the calculations correctly upon their first attempt.
- **Once the calculations are correct,** a code is provided to the student.
 - This code must be included on the laboratory report cover.
 - The number of attempts, and the calculation error [%], as compared to the expected calculated value, will be taken into consideration when grades are assigned.

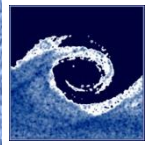

After the laboratory measurement

- Example:

Sajnos a számítása helytelen. Kérjük ellenőrizze a bevitt adatokat és próbálja Próbálkozások száma: 7.

* Beszívóelemen mért nyomásesés (3. térfogatáram):	300	[Pa]
* Mérőperemen mért nyomásesés (1. térfogatáram):	400	[Pa]
* Mérőperemen mért nyomásesés (2. térfogatáram):	500	[Pa]
* Mérőperemen mért nyomásesés (3. térfogatáram):	600	[Pa]

Származtatott mérési adatok

Hőmérséklet:	kihagy	[K]
* Levegő sűrűsége:	1.18	[kg/m ³]
* Levegő kinematikai viszkozitása:	1.507e-5	[m ² /s]

Elfogadva!

Elfogadva!

Kalibráció (1. térfogatáram)

Mérőperem átfolyási tényező, C (1. lépés):	0.6	[-]
Térfogatáram (1. lépés szerint):	kihagy	[m ³ /s]
Sebeség (1. lépés szerint):	kihagy	[m/s]
* Reynolds-szám (1. lépés szerint):	30e3	[-]
Mérőperem átfolyási tényező, C (2. lépés):	kihagy	[-]
* Mérőperem átfolyási tényező, C (végleges):	0.65	[-]
* Térfogatáram (végleges):	0.025	[m ³ /s]
* Beáramlási tényező:	1.8	[-]

Elfogadva!

Pontatlan számítási eredmény!

Elfogadva!

Pontatlan számítási eredmény!

Pontatlan számítási eredmény!

Kalibráció (2. térfogatáram)

Mérőperem átfolyási tényező, C (1. lépés):	0.6	[-]
Térfogatáram (1. lépés szerint):	kihagy	[m ³ /s]
Sebeség (1. lépés szerint):	kihagy	[m/s]
* Reynolds-szám (1. lépés szerint):	31e3	[-]

Elfogadva!

Elfogadva!

- It is not mandatory to fill out the grey cells..
- If the program deems the calculations incorrect, then it might be useful to fill out these cells, in order to help one find the source of the error.

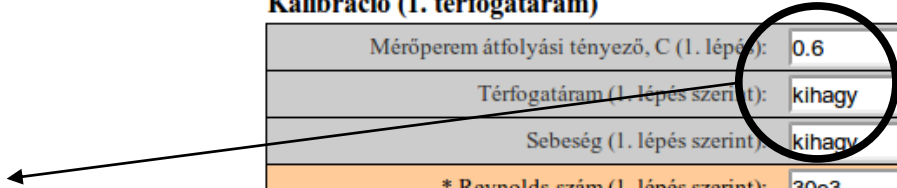

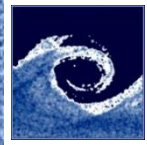

After the laboratory measurement

- After the calculations are accepted, the reports must be submitted through the poseidon network.
- Reports must be submitted by midnight of the second Sunday following the measurements.
- Consultations:
 - The faculty members grading the reports will provide one consultation opportunity per week for each measurement (one hour per measurement per week) they are grading. Consultation timetables can be found on the department web site.
 - The measurement groups can also come to the laboratory to consult with the supervisors overseeing the given measurements during the last 15 minutes of any regular measurement session.

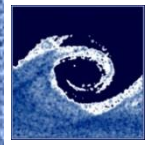

After the laboratory measurement

- Requirements of laboratory reports
 - The cover of the laboratory report must be downloaded from the web site.
 - The lab report can only be 6 pages long plus the required report cover and mandatory annex
 - A mandatory annex to the 6 pages needs to contain the following:
 - A scanned copy of the hand written notes which were signed upon completion of the laboratory measurement, and which contain all the tables of all the data which was recorded.
 - The uploaded zip file must contain an excel file in which the calculations were made and the pdf of the laboratory report.
- ALL LABORATORY REPORTS NEED TO BE ORIGINAL AND MADE BY THE LAB GROUP! ANY MEASUREMENT LEADERS SUBMITTING WORK WHICH WAS NOT SOLELY PRODUCED BY THE GROUP, WITHOUT CITING THE APPROPRIATE SOURCE, WILL BE REPORTED TO THE DEAN'S OFFICE AND THE ETHICS COMMITTEE IN ACCORDANCE WITH THE RULES OF THE TVSz.

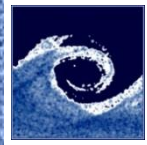

After the laboratory measurement

- The reports are evaluated within 2 working days, and a message is sent to the student through the poseidon network informing the student whether the report was accepted or not. If the report is unacceptable, there is one opportunity to resubmit the report by the following Sunday at midnight.
- Please note that in some cases the reports need to be submitted earlier in order to make sure that presentations can be presented when needed.

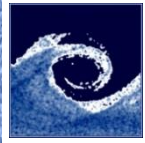

Presentation

- The template for the presentations, which is also an example for a typical presentation, can be downloaded from the webpage.
- 8 minutes
- The measurement needs to be summarized.
- The personal measurement assignment needs to be presented and explained.
- The measurement stand and the used equipment needs to be presented.
- Error calculations need to be presented.
- The evaluation of the results needs to be presented.
- The results need to be shown
- The conclusions and results need to be summarized.

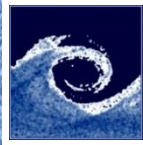

Checklist

At the measurement:

- In preparing for the measurement (hand written measurement plan): assignment, neptun code, name, documentation, personal assignment, mm paper, signature. CHECK
- The laboratory instructor checks your preparedness with 1 or 2 questions CHECK
- Record atmospheric conditions (p_0 , T_0) before and after the laboratory CHECK
- Calibrate to the Betz micro manometer CHECK
- You can ask questions from any of the laboratory instructors at the laboratory session, but it is advised to ask from the one leading your measurement
- Check the list of supplies in your measurements box. The box will be opened and closed by the laboratory instructor. The laboratory instructor will provide manometers, and will replace those which need to be charged. Do not connect digital manometers to chargers!

Consultation

- Consultations can be made with the appropriate instructor during consultation hours.
- Calculation results need to be checked www.ara.bme.hu/lab
- Once calculations are correct and the report is complete, submit the report: www.ara.bme.hu/poseidon (pdf+xls)
- pdf name = surname_NEPTUNCODE_AorB_DAY_time_ODDorEVEN_M#.pdf

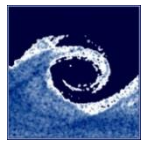

Determining the uncertainty of the results (error calculation) I.

Example: Velocity measurement uncertainty

Dynamic pressure measured using a Pitot-static (Prandtl) tube:

$$p_d = 486.2 \text{ Pa}$$

Atmospheric conditions experienced in the lab:

$$p_0 = 1010 \text{ hPa} \quad ; \quad T = 20^\circ\text{C} \quad (293\text{K});$$

Specific gas constant of air

$$R = 287 \text{ J/kg/K}$$

$$v = \sqrt{\frac{2}{\rho_{air}} \cdot \Delta p_d} \quad \rho_{air} = \frac{p_0}{R \cdot T}$$

$$v = \sqrt{\frac{2}{p_0} \cdot \Delta p_d RT}$$

$$v = 28.45 \frac{m}{s} \quad \rho_{air} = 1.2 \frac{kg}{m^3}$$

$$v = f(T, p_0, \Delta p_d, \text{const. values})$$

Quantities having uncertainties (X_i):

- The measurement uncertainty of the atmospheric pressure comes from the error arising when reading the scale: $\delta p_0 = 100 \text{ Pa}$
- The measurement uncertainty of the atmospheric temperature in the lab: $\delta T = 1 \text{ K}$
- The pressure measurement uncertainty arising when making a measurement using a Pitot-static (Prandtl) probe and a EMB-0XY digital manometer: $\delta(\Delta p_i) = 2 \text{ Pa}$

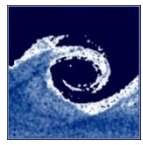

Determining the uncertainty of the results (error calculation) II.

Example: Velocity measurement uncertainty

Typical calculation of absolute error:

$$\delta R = \sqrt{\sum_{i=1}^n \left(\delta X_i \cdot \frac{\partial R}{\partial X_i} \right)^2}$$

$$R = v$$

$$X_1 = T; X_2 = p_0; X_3 = \Delta p_d$$

$$(\delta p, \delta T, \delta(\Delta p_d))$$

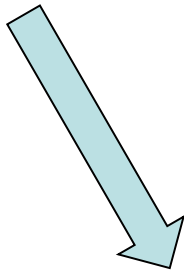

$$\frac{\partial v}{\partial T} = \sqrt{2R} \cdot \frac{1}{2} \cdot T^{-\frac{1}{2}} \cdot \frac{1}{\sqrt{p_0}} \cdot \sqrt{\Delta p_d} = 0,00366 \frac{m}{s \cdot K}$$

$$\frac{\partial v}{\partial p_0} = \sqrt{2R} \cdot \sqrt{T} \cdot \frac{-1}{2} \cdot p_0^{-\frac{3}{2}} \cdot \sqrt{\Delta p_d} = 1,4 \cdot 10^{-4} \frac{m}{s \cdot Pa}$$

$$\frac{\partial v}{\partial \Delta p_d} = \sqrt{2R} \cdot \sqrt{T} \cdot \frac{1}{\sqrt{p_0}} \cdot \frac{1}{2} \cdot \Delta p_d^{-\frac{1}{2}} = 0,029 \frac{m}{s \cdot Pa}$$

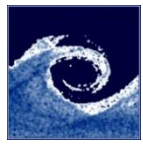

Determining the uncertainty of the results (error calculation) III.

Example: Velocity measurement uncertainty

The absolute uncertainty of the velocity measurement:

$$\delta v = \sqrt{\left(\delta T \cdot \sqrt{\frac{2R}{p_0}} \Delta p_d \cdot \frac{1}{2} \cdot T^{-\frac{1}{2}} \right)^2 + \left(\delta p_0 \cdot \sqrt{2 \cdot R \cdot T} \cdot \Delta p_d \cdot \frac{-1}{2} \cdot p_0^{-\frac{3}{2}} \right)^2 + \left(\delta(\Delta p_d) \cdot \sqrt{\frac{2 \cdot R \cdot T}{p_0}} \cdot \frac{1}{2} \cdot \Delta p_d^{-\frac{1}{2}} \right)^2}$$

$$\delta v = 0.05977 \frac{m}{s}$$

The relative uncertainty of the velocity measurement:

$$\frac{\delta v}{v} = 0.0021 = 0.21\%$$

The result of the velocity measurement:

$$v = 28.45 \pm 0.05977 \frac{m}{s}$$