

Prediction of wind load acting on telecommunication masts

Márton **BALCZÓ** Ph.D. Student, **István GORICSÁN** Ph.D., Ass. Professor
Tamás LAJOS Ph.D., Dr.Sc. Professor, **Tamás RÉGERT** Ph.D. Ass. Professor,
Budapest University of Technology and Economics

Tamás KOVÁCS Civil Engineer, T-Mobile Budapest, Hungary,
Péter SEBESTYÉN Civil Engineer, Pannon-GSM, Budapest, Hungary



IABSE 2006 Annual Meetings and Symposium Budapest

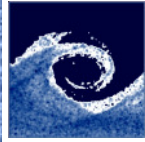

Introduction

- Growing demand for installing more aerials on telecommunication masts > increased wind load > limitation by strength of the structures > reinforcement or replacement of towers > extra costs, difficulties in implementation
- Crash statistics > strength calculation may be too conservative (out of 225 failures only 7 were caused by wind overload, wind-storm in 1999 in Denmark)
- 50-70% of the wind load acts on the mast > considerable reserve in load capacity could be proven by calculating with realistic wind loads acting on mast.
- There is a demand to use more accurate and reliable data on wind load depending also on the atmospheric turbulence, roughness of components and aerodynamic interaction of components, aerials and cables.
- Service provider Pannon initiated in 2003 a wind tunnel investigation of aerodynamic load acting on real mast components (legs and bracing members) to explore the reserves in strength of masts.
- Results of the measurements were shared with two other service providers active in Hungary > investigations was continued together with T-Mobile in the Theodore von Kármán Wind Tunnel Laboratory of Department of Fluid Mechanics of Budapest University of Technology and Economics.

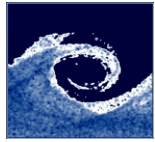

Drag force acting on cylinders

Drag force: $F_e = \frac{\rho}{2} v_{\text{ref}}^2 L D c_D$

Drag coefficient: $c_D = \frac{F_e}{\frac{\rho}{2} v_{\text{ref}}^2 D L}$

$c_D = c_D(\text{Re}, \text{Tu}, k_s/D, L/D)$

Reynolds number: $\text{Re} = \frac{v_{\text{ref}} D}{\nu}$

Turbulence intensity: $\text{Tu} = \frac{\sqrt{v'^2}}{v} 100\%$

Relative surface roughness: k_s/D

Relative length: L/D

Smooth cylinders in low turbulence flow, influence of Reynolds number:

Subcritical: $\text{Re} < 10^5$, $c_D = 1,2$, $c_s = 0,4 - 0,7$

Supercritical: $3 \cdot 10^5 < \text{Re} < 3 \cdot 10^6$, $c_D = 0,3 - 0,4$, $c_s < 0,1$

Tanscritical: $\text{Re} > 3 \cdot 10^6$, $c_D = 0,5 - 0,7$, $c_s = 0,5 - 0,7$

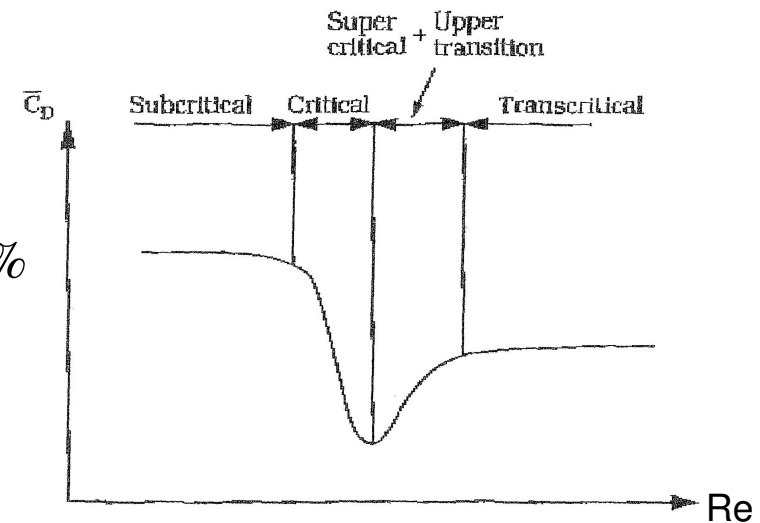
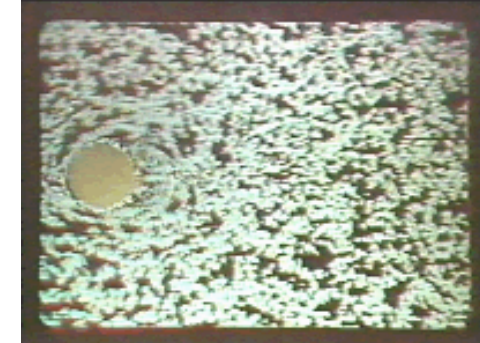
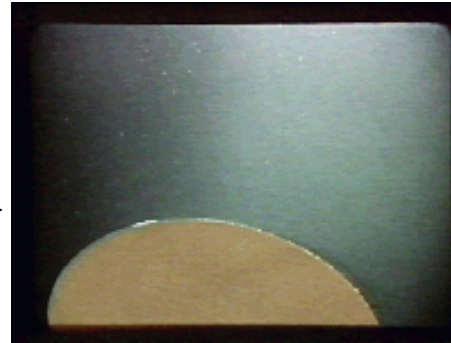

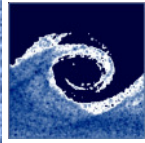

Effect of turbulence intensity, roughness and relative length on drag coefficient

Tu Increasing turbulence intensity: considerable shift of transition towards smaller Reynolds number.

Standard atmospheric velocity distributions:

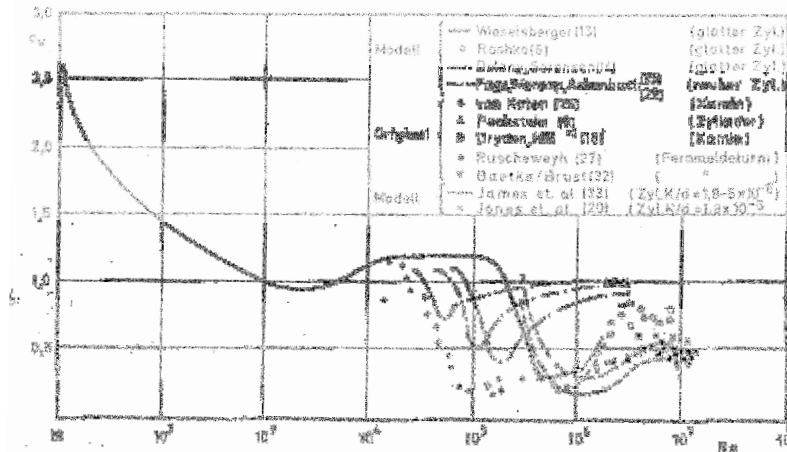
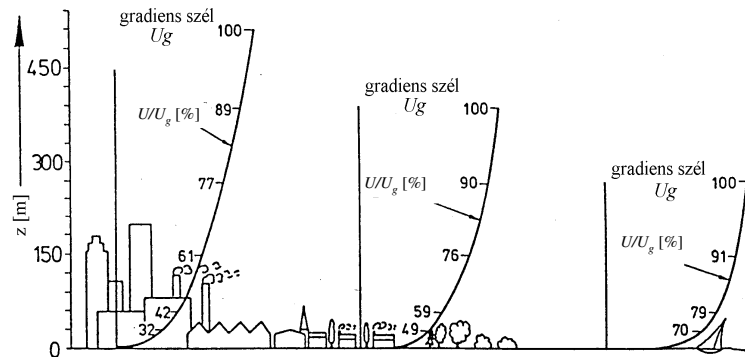

L/D

Significant effect in subcritical regime decreasing length → decreasing drag

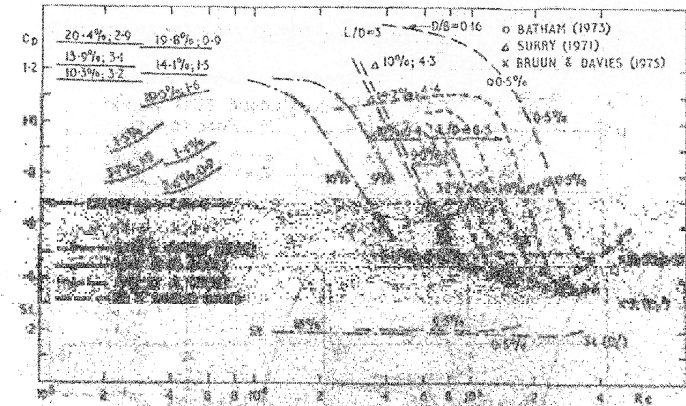

Standard atmospheric turbulence intensity distributions

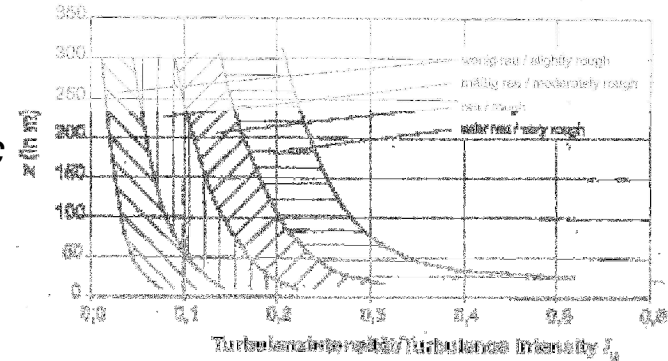

ks/D

Increased roughness: shift of transition towards smaller Reynolds number, but considerable increase of drag in supercritical flow regime.

L/D = ∞ 40 20 10
 Cd = 1,2 0,98 0,91 0,82

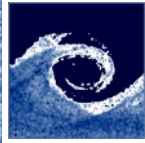

Wind tunnel

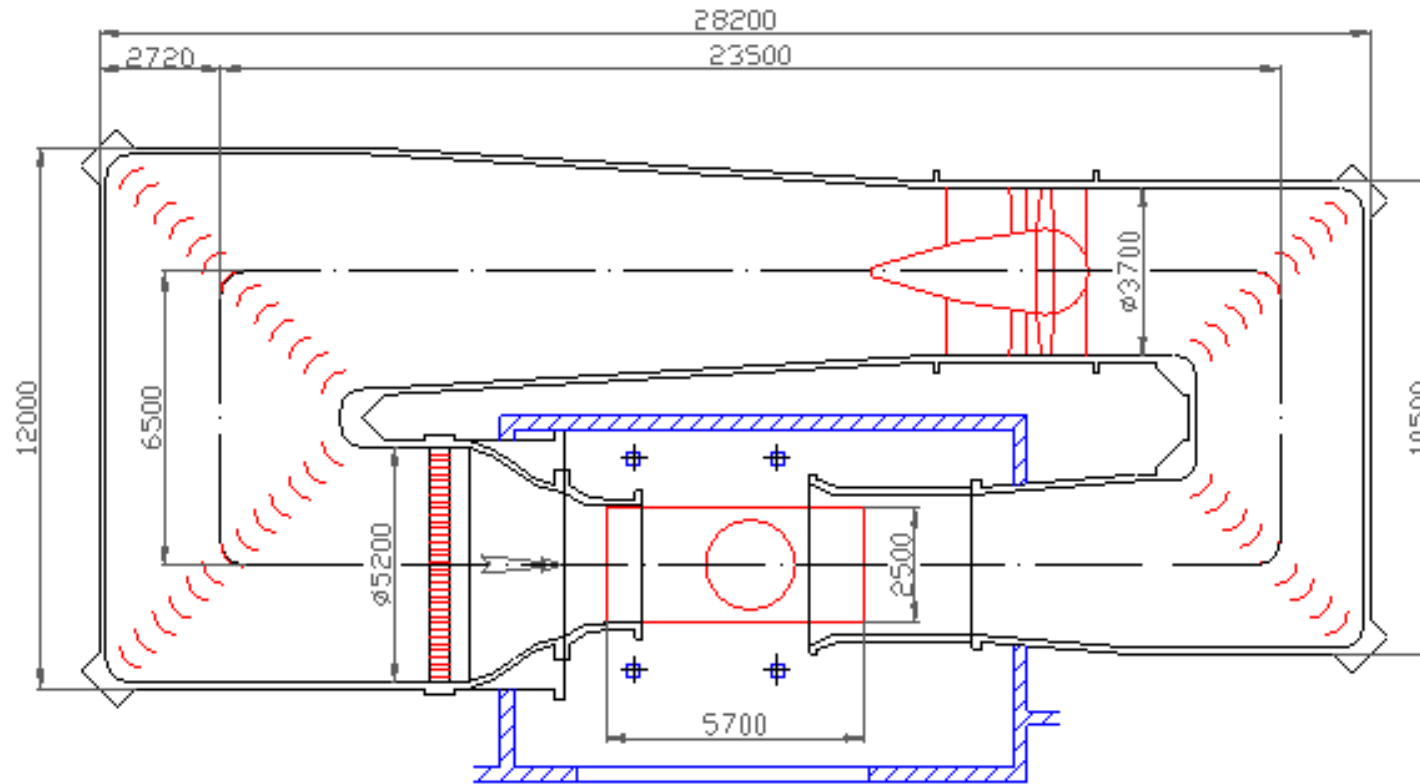

**Test section: length 5.7 m,
nozzle diameter 2.6 m,
maximum wind velocity
60 m/s, turbulence
intensity in empty test
section 0.45%**

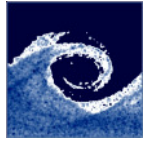

Experimental setup

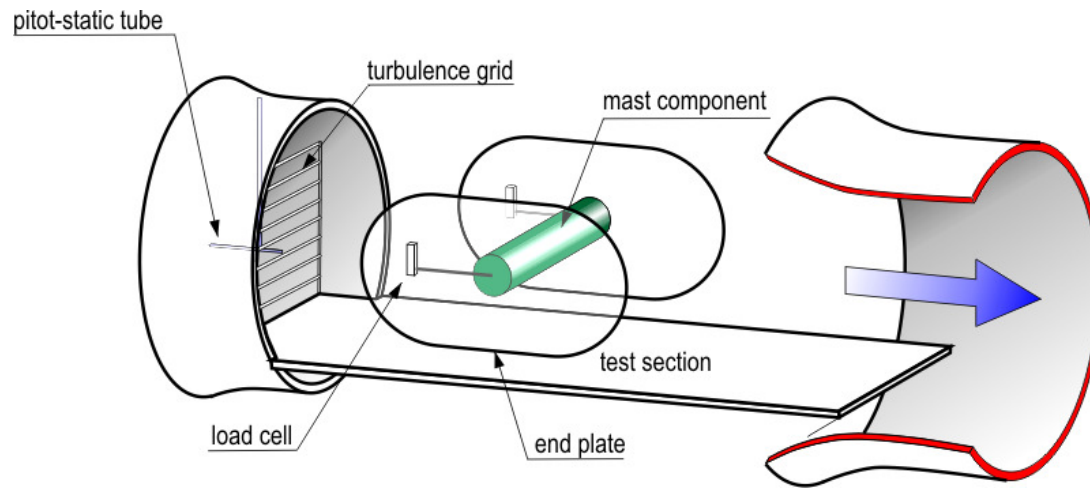

Increase of turbulence intensity by grids

($Tu=0,45\%$, 5% , $7,5\%$)

End plates ensure 2D flow

Drag force measurement by using load cells

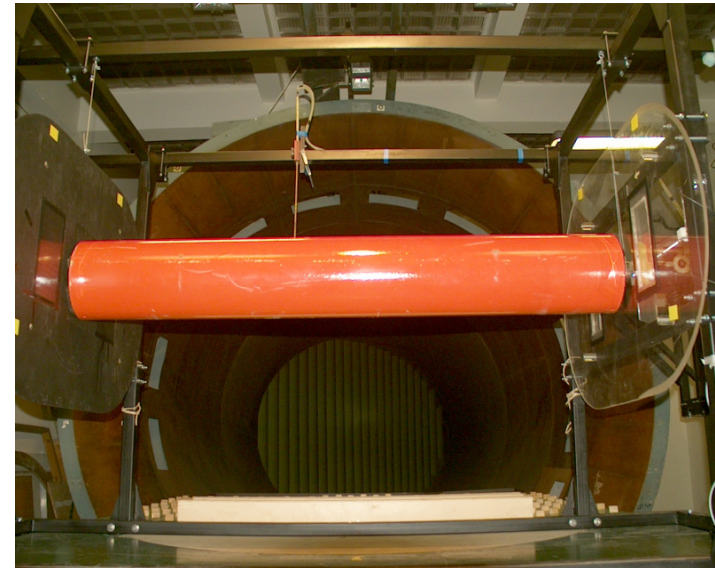
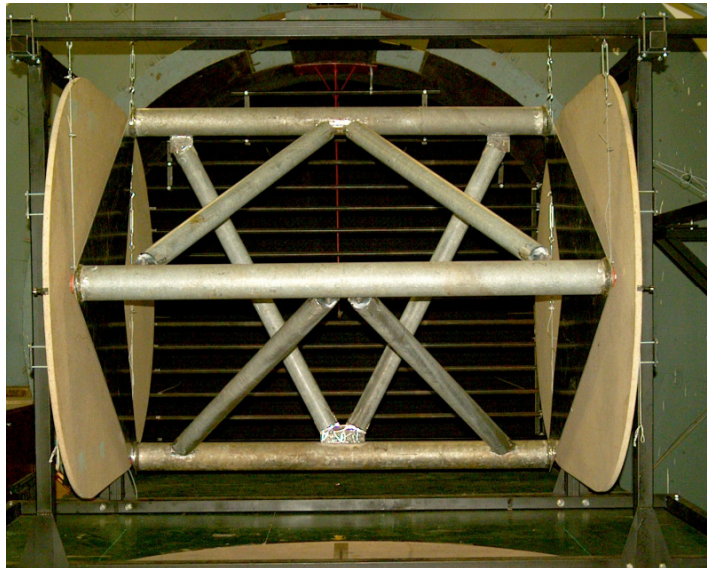

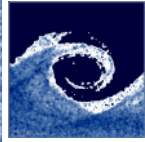

Effect of surface treatment

Drag coefficient of painted and hot dip galvanized cylindrical legs of various diameters at low turbulence intensity ($Tu = 0,45\%$)

Smooth (painted) leg
supercritical flow at
 $Re_{crit} = 3.3 \cdot 10^5$ with $c_D = 0.4$.
At legs of bigger surface
roughness (hot dip
galvanized) supercritical
flow at $Re_{crit} = 2.6 - 2.8 \cdot 10^5$
with $c_D = 0.46$.

**The surface roughness at
usual surface treatments
is too small to influence
the sub-supercritical
transition significantly. At
larger roughness the
transition starts at slightly
smaller Reynolds number.**

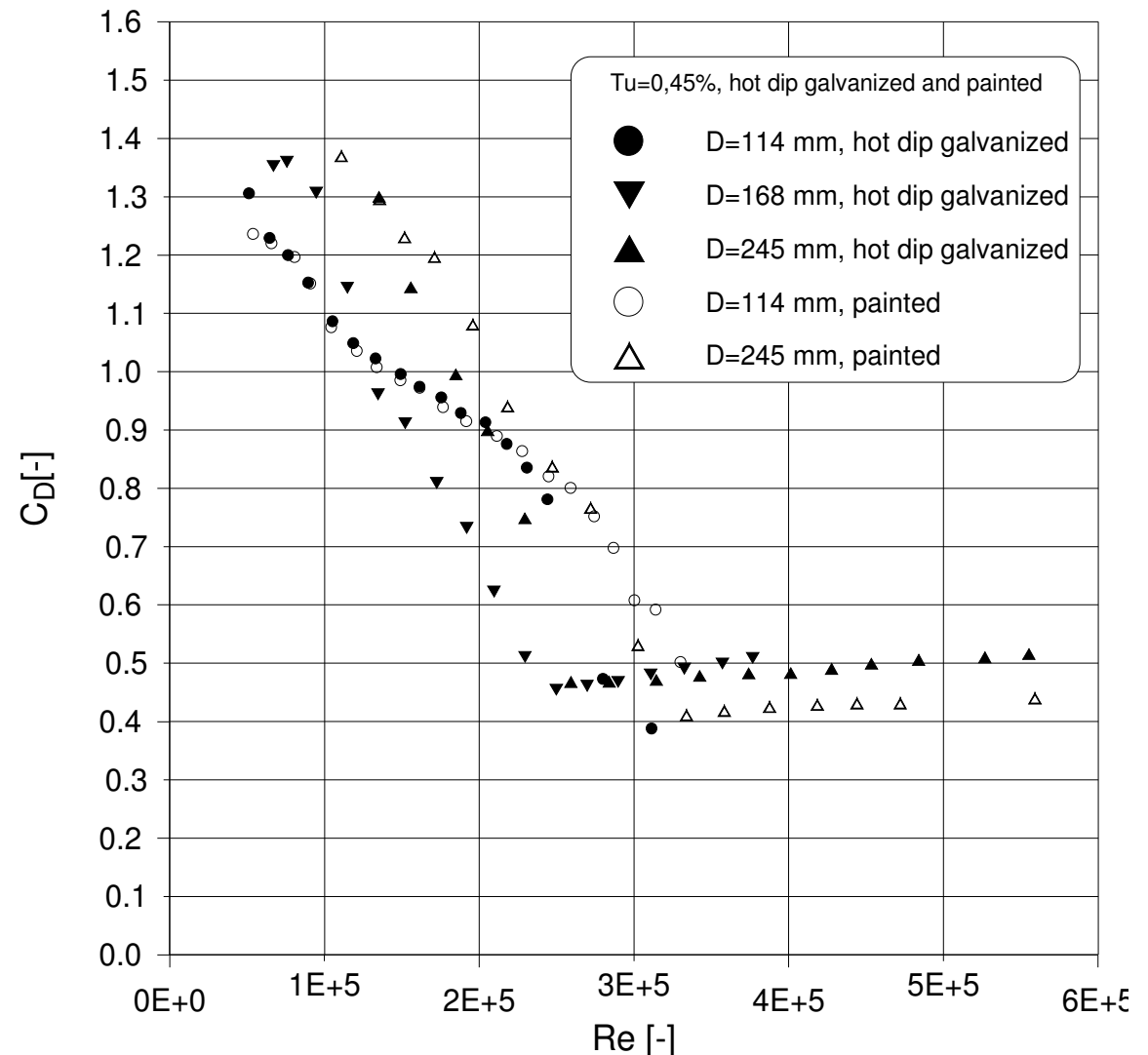

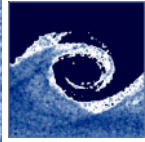

Effect of turbulence intensity

Drag coefficient of painted and hot dip galvanized cylindrical legs of various diameters at higher ($Tu = 5\%$) turbulence intensity

The sub-supercritical transition occurs at Re range $0.5 - 1.5 \cdot 10^5$ irrespective of the roughness. In turbulent flow the supercritical c_D of legs of smooth surfaces is by $\Delta c_D \approx 0,1$ smaller.

The turbulence intensity influences the transition processes significantly: the critical Reynolds number Re_{crit} decreases from $2,6 - 3 \cdot 10^5$ to max. $1,5 \cdot 10^5$.

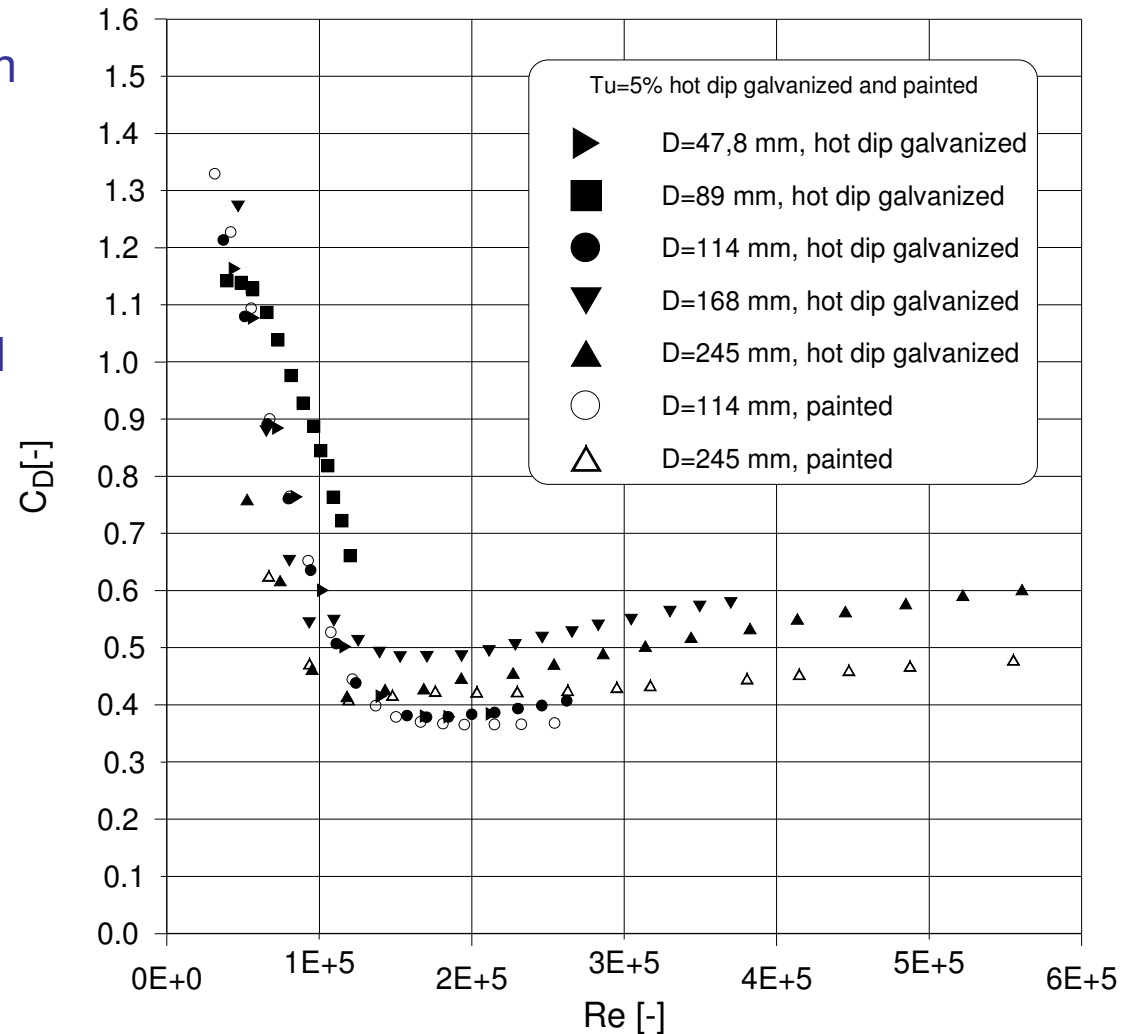

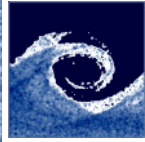

The combined effect of roughness and turbulence intensity

Drag coefficient of painted and hot dip galvanised cylindrical legs of D=245mm diameter at various (Tu =0,45, 5 and 7,5%) turbulence intensities

The increase of turbulence intensity from 0,45% to 5% causes a substantial (66%) reduction in Re_{crit} . Further increase from 5% to 7,5% decreases slightly both Re_{crit} and the smallest drag coefficient.

The turbulence intensity is the dominant parameter in shifting of sub-supercritical transition towards smaller Reynolds number. Increase of both roughness and turbulence intensity increase the super-critical drag coefficient.

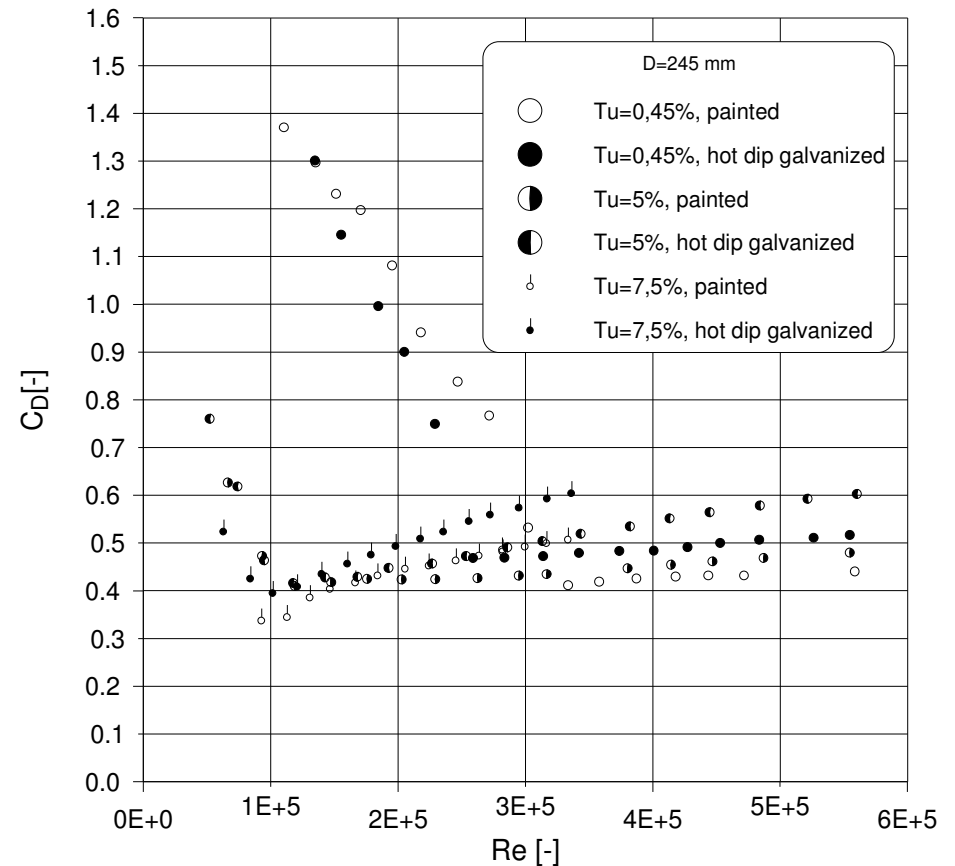

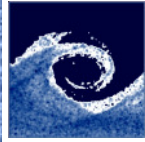

Measurement of a mast section

Drag coefficient of a mast section consisting of hot dip galvanized legs and bracing members of $D = 108$ and 75 mm, respectively, at $Tu = 5\%$. Re and c_D were calculated with diameter of the leg and with the projected area of two legs and two bracing members constituting one side of the mast of triangular cross section, respectively.

Average drag coefficient related to legs and bracing members can be estimated $c_{D_{mean}} = 0.7$ and 0.53 , respectively. Good agreement is found when comparing these estimated drag coefficients to that measured for hot dip galvanised cylinders.

This experiment verifies the adaptability of results of measurements of components for calculating the drag acting on the mast.

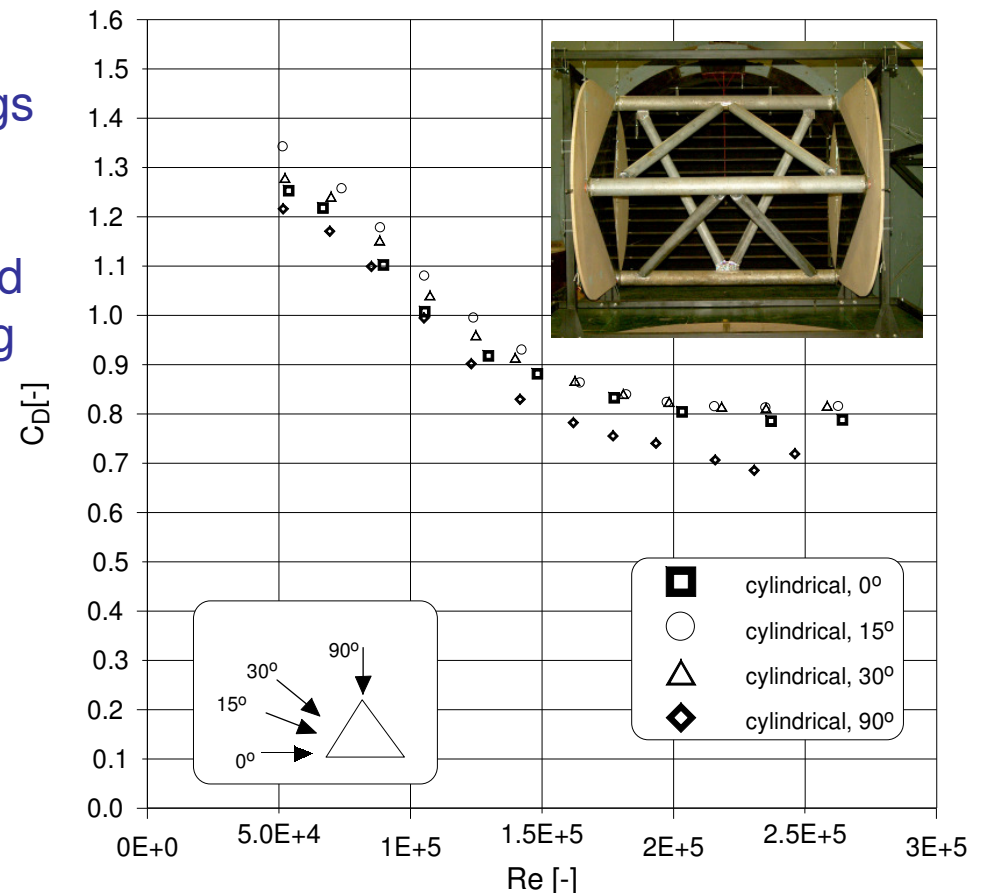

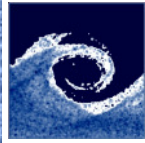

Numerical simulation of the flow past mast section

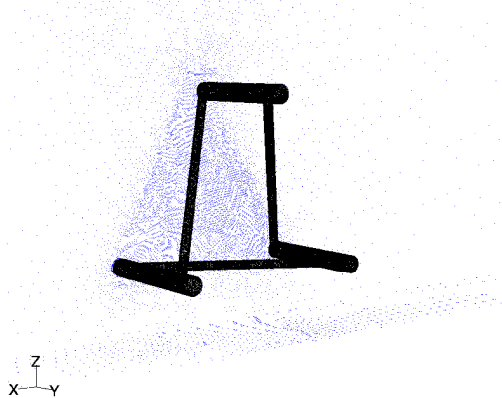

Computational domain

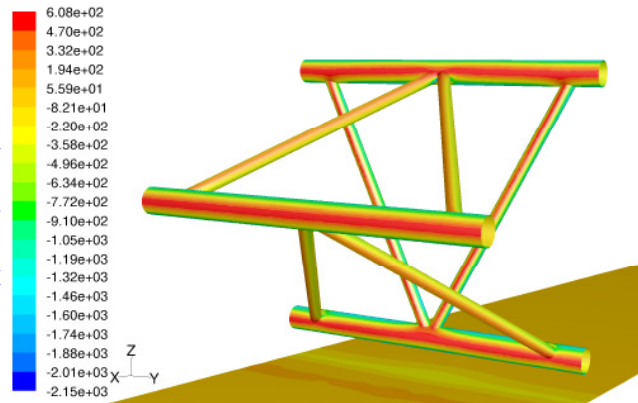

Pressure distribution

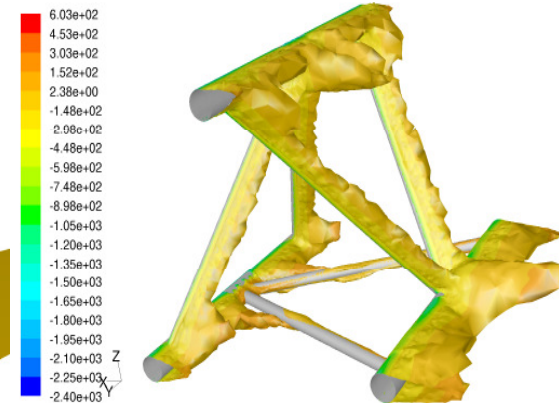

Total pressure isosurfaces

Two wind directions (0° and 90°), FLUENT 6.2 code, grid of 760.000 tetrahedral cells, 3-dimensional space, turbulence model: Reynolds Averaged Navier Stokes (RANS). Calculated and measured drag coefficients at 0° wind direction $c_D = 0.71$, and 0.79 , at 90° $c_D = 0.69$ and 0.71 , respectively.

The numerical simulation makes possible to determine the aerodynamic interaction of mast components as well as the sheltering effect of aerials, cables.

Numerical simulation of the environment of the mast (vegetation, features of terrain, buildings) based on relevant meteorological data would provide reliable and realistic data on local wind velocities for stress analyses.

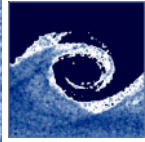

Conclusions

- 1) In case of low turbulence and smooth surface of mast components the sub-supercritical transition takes place in a quite large (≥ 200.000) Reynolds number range: the aerodynamic drag acting on circular cylinders reaches its minimum value, $c_D \cong 0,4$ at relatively high critical Reynolds number $Re_{crit} \geq 300.000$.
- 2) No significant reduction of critical Reynolds number can be achieved with surface roughness belonging to usual surface treating of the mast components. Large relative roughness can considerably reduce Re_{crit} , but the drag in supercritical domain is relatively high: $c_D = 0.8- 0.9$.
- 3) The supercritical flow regime with low ($c_D = 0.4 - 0.5$) drag can be achieved at $Tu = 5\%$ turbulence intensity already at Reynolds number $Re = 100.000-150.000$. This turbulence intensity (enhanced by upstream components) is present at all ground roughness in the lower part (height over the ground ≤ 80 m) of atmospheric boundary layer. So it is recommended that the stress analyses of masts should be consider supercritical Reynolds number range starting at critical Reynolds number $Re = 150.000$.

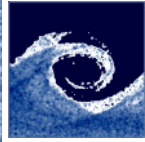

Conclusions (cont'd)

- 4) The decrease of roughness of hot dip galvanised parts with painting increases the load capacity by 10-14 % in supercritical regime.
- 5) Calculations carried out on the basis of Eurocode, using the findings of this wind tunnel tests result at least 5 - 20% savings in the different structural elements of a mast compared to the calculations based on Hungarian Standards.
- 6) Numerical simulation of the flow past mast section provided encouraging results. Further studies are needed to develop a reliable CFD model with which the wind force acting on mast, aerials and cables can be predicted with necessary accuracy. Regarding the rapid development of CFD numerical simulation of the flow past whole mast with aerials and its environment can be determined that would give reliable initial data for stress analyses.

