

# Basics of vehicle aerodynamics

Prof. Tamás Lajos  
Budapest University of Technology and Economics  
Department of Fluid Mechanics

University of Rome „La Sapienza”  
2002

# Influence of flow characteristics on the operation of vehicles

Objectives of improvement of flow past vehicle bodies:

- reduction of **fuel consumption**
- more favourable **comfort characteristics** (mud deposition on body, noise, ventilating and cooling of passenger compartment)
- improvement of **driving characteristics** (stability, handling, traffic safety)

Vehicle aerodynamics includes three interacting flow fields:

- flow past vehicle body
- flow past vehicle components (wheels, heat exchanger, brakes, windshield),
- flow in passenger compartment

# Approaches in vehicle aerodynamics 1

**1900-1920** Adaptation  
of shapes from other  
fields

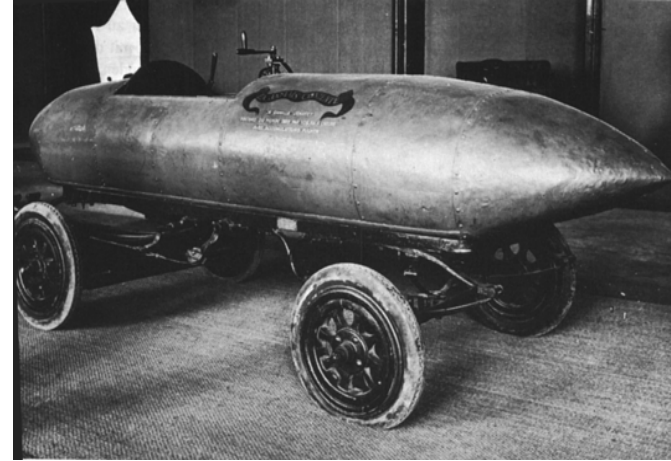

**Torpedo**

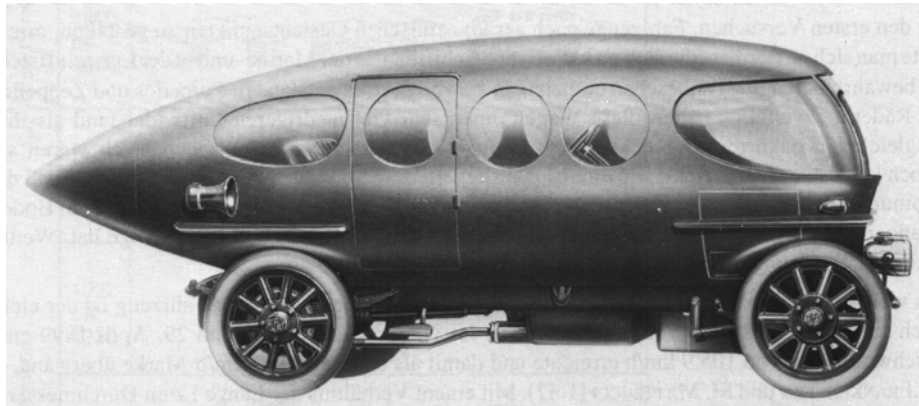

**Airship**

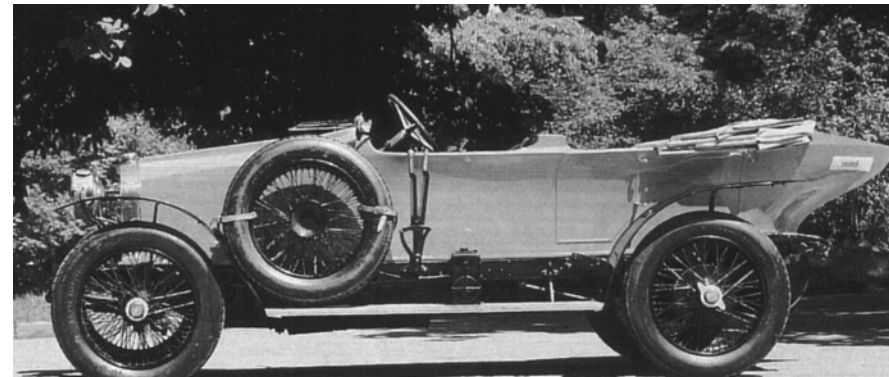

**Boat**

# Approaches in vehicle aerodynamics 2

**1920-1970** Adaptation of results of airplane and airship development: streamlining

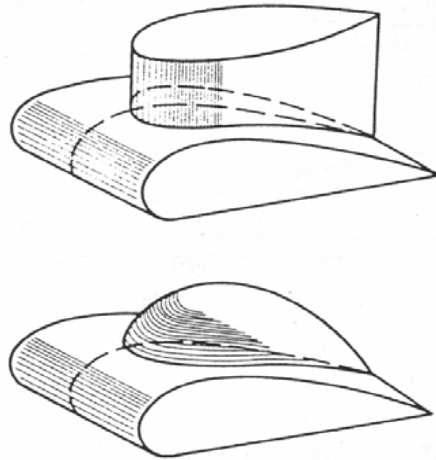

**Járay experimental cars**



# Approaches in vehicle aerodynamics 3

## 1970-1990 Detail optimisation

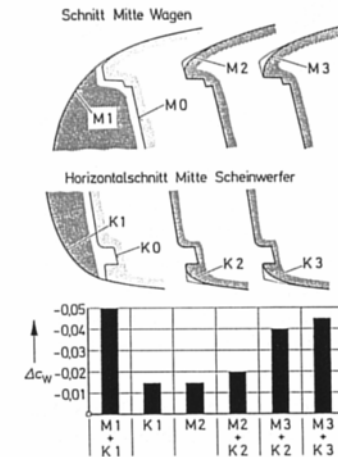
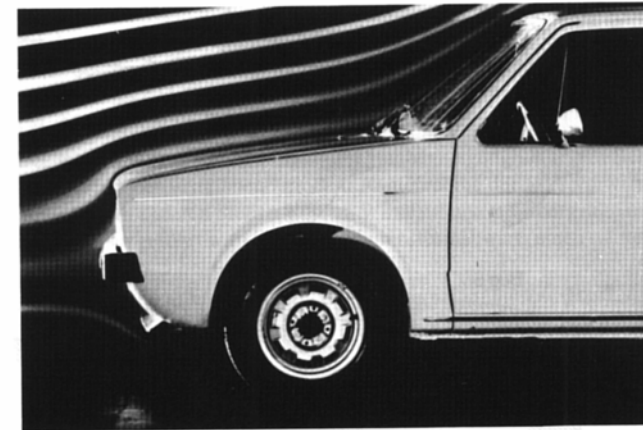
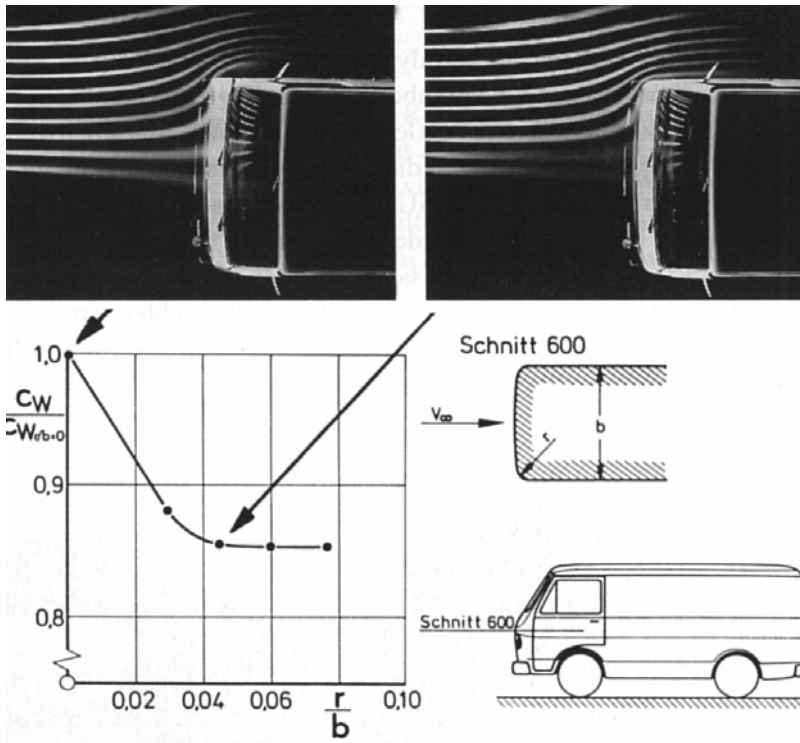

# Approaches in vehicle aerodynamics 4

1990 - Basic form optimisation

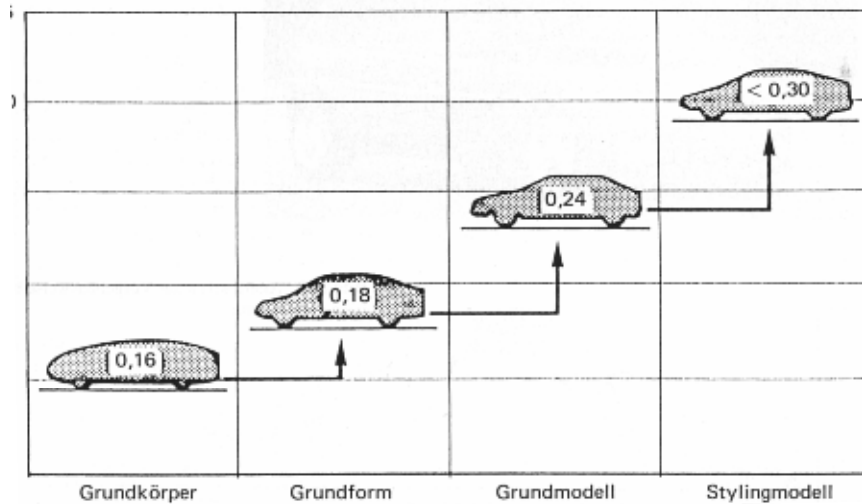
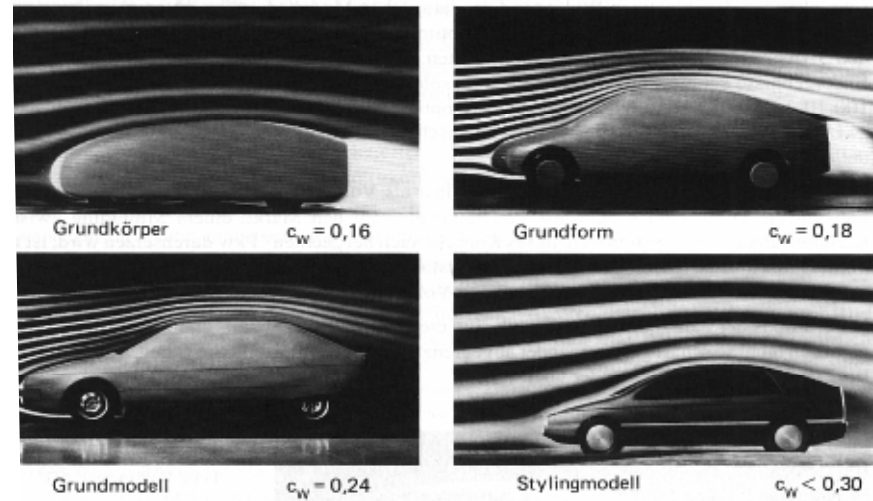

# Change of drag coefficient of cars

Drag coefficient

$$c_D = \frac{F_D}{\frac{\rho}{2} v^2 A}$$

$$P_{ae} = \frac{\rho}{2} v^3 A c_D$$

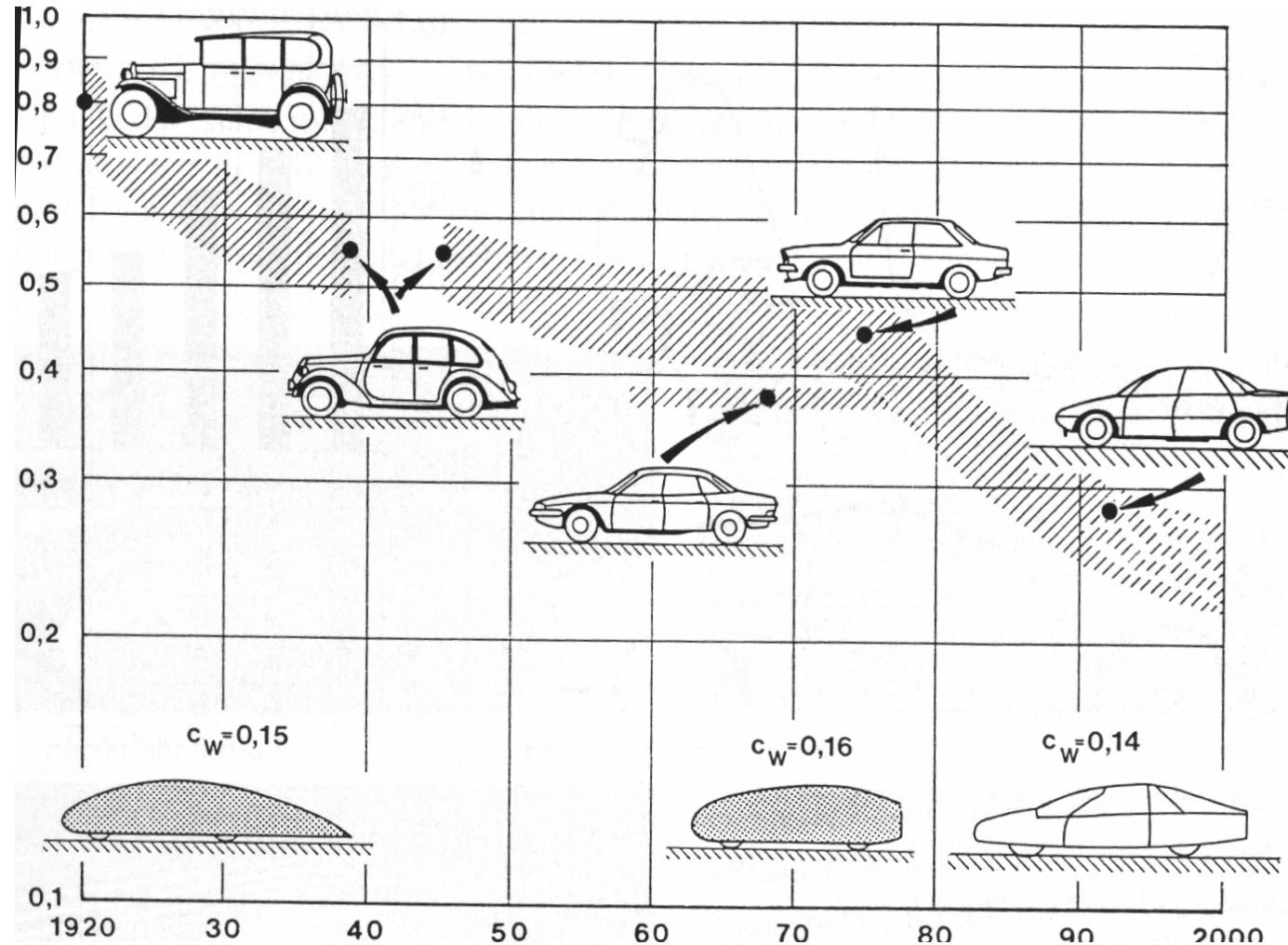

# Characteristics of flow past vehicle bodies

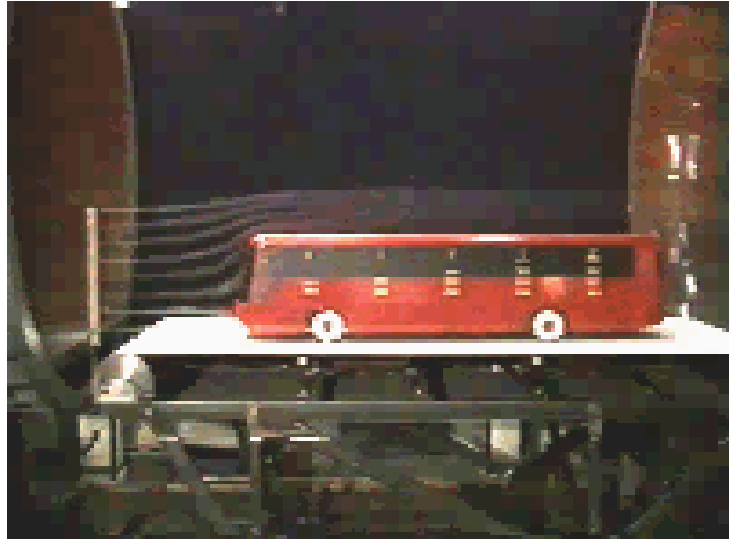

Complex 3D turbulent flow in relative co-ordinate system.

Classification of flow field:

Flow past

- front,
  - side walls and roof,
  - in underbody gap,
  - behind the rear wall (wake).
- **Front:** stagnation point, overpressure, accelerating flow
  - **Side walls, roof:** boundary layer separation depending on the rounding up of leading edges around the front.
  - **Rear wall:** in separation bubble nearly constant pressure below the ambient, strong turbulent mixing
  - **Underbody gap:** surrounded by „rough” and moving surfaces, decreasing velocities downstream, sideward outflow



# Relation between curvature of streamlines and pressure distribution

$$\frac{\partial p}{\partial n} = \rho \frac{v^2}{R} \quad \text{where}$$

n co-ordinate normal to streamline  
R radius of streamline curvature



If the streamlines are curved **pressure increases** perpendicular to them, outwards from the centre of curvature

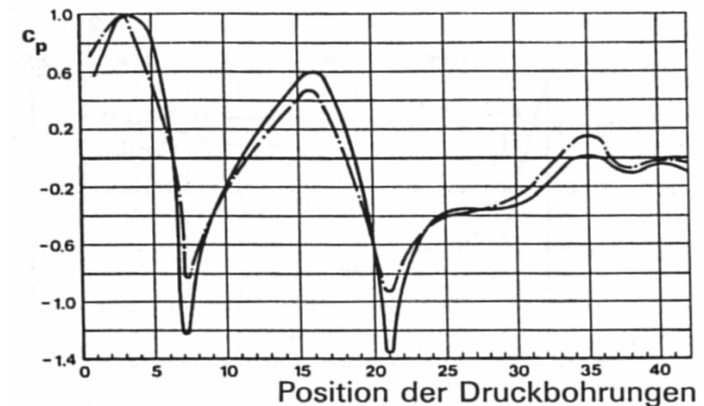

AUDI 100 II

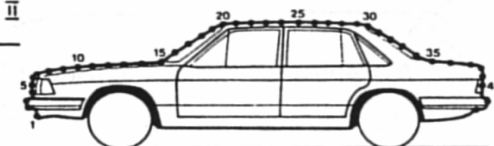

# Aerodynamic forces and viscosity

In case of inviscid flow  $\tau=0$  (no shear stresses exist) and  $-\int p d\underline{A} = 0$  the resultant of pressure forces is  $\hat{0}$ . (In case of cylinder symmetrical flow field.)

So  $\underline{F}_{aer} = 0$

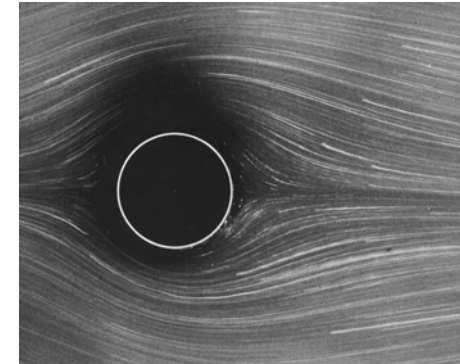

In case of viscous flow  $\tau \neq 0$  (shear stresses exist) and  $-\int p d\underline{A} \neq 0$  (the resultant of pressure forces is different from 0). In case of cylinder non-symmetrical flow field.

So  $\underline{F}_{aer} \neq 0$

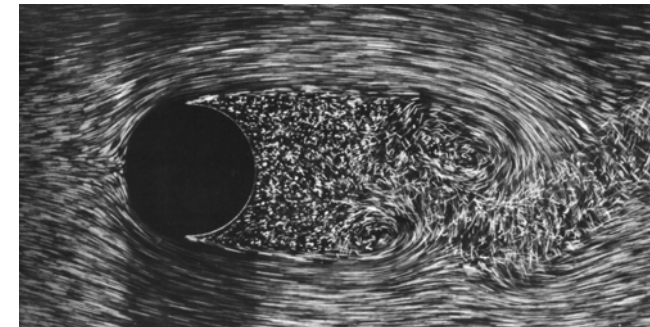

# Cause of drag forces at streamlined and bluff bodies

**Streamlined bodies** are characterized by attached flow. The share of pressure forces in drag force (component of aerodynamic force parallel to undisturbed flow) is small. Drag is caused mainly by shear stresses. Since shear forces are small  $c_D$  is relatively small.

**Bluff bodies** are characterized by boundary layer separation and separation bubbles. Drag is caused mainly by pressure forces, since  $p - p_0 \gg \tau$   $c_D$  is relatively big.

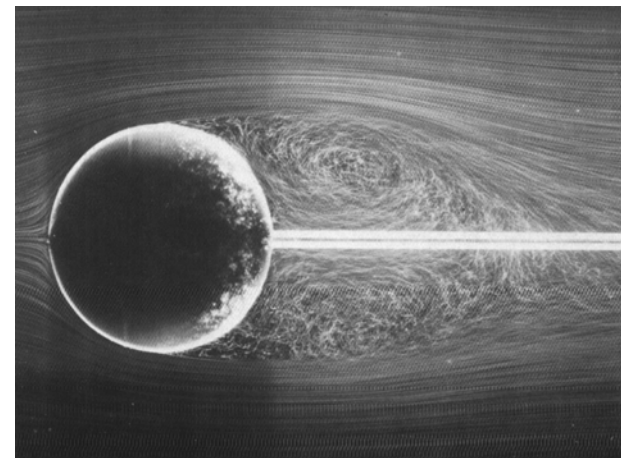
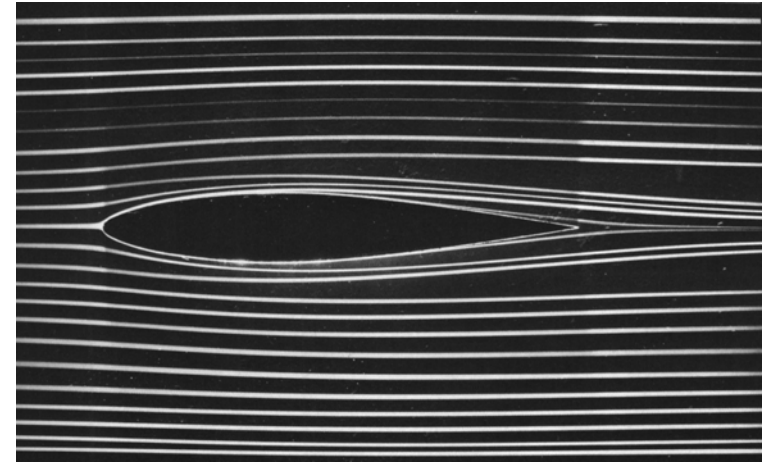

# Boundary layer (BL) separation

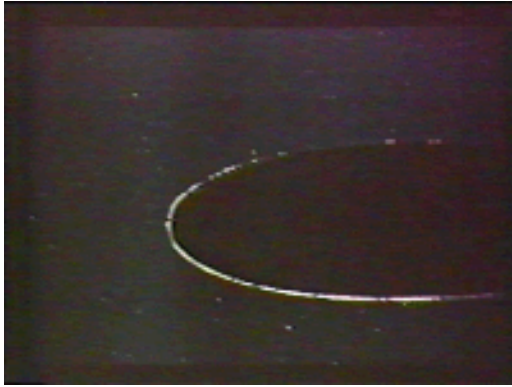

**On solid surface BL develops**

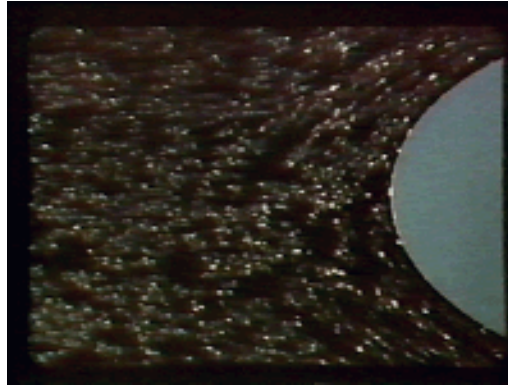

**Adverse pressure gradient over the plate**

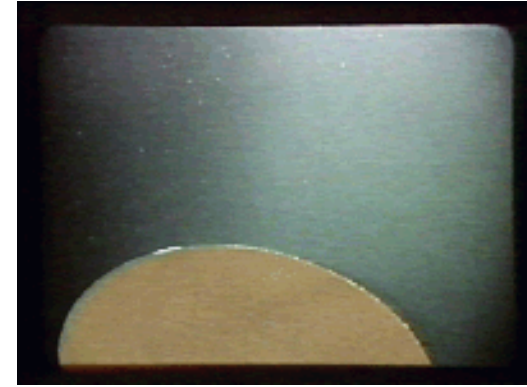

**Separation bubble is confined by shear layer**

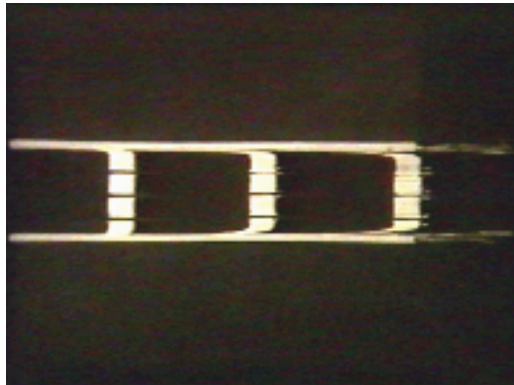

**Adverse pressure gradient causes BL separation**

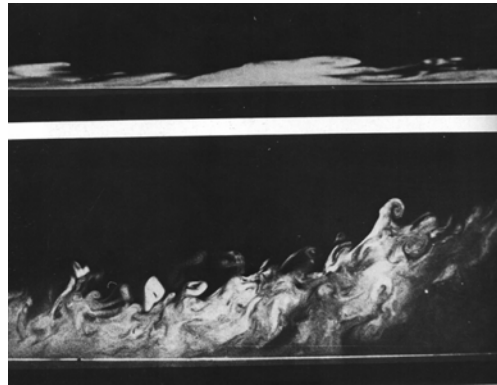

**BL at accelerating and decelerating flow**

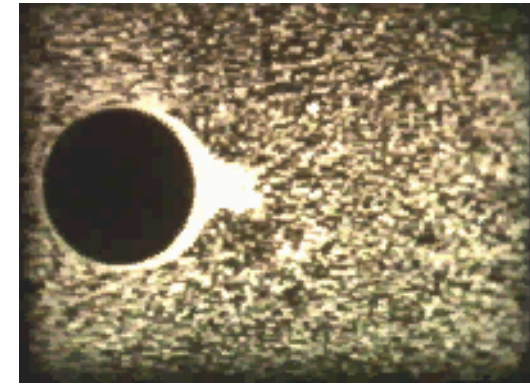

**BL separation causes asymmetry in flow field**

# Where to expect BL separation

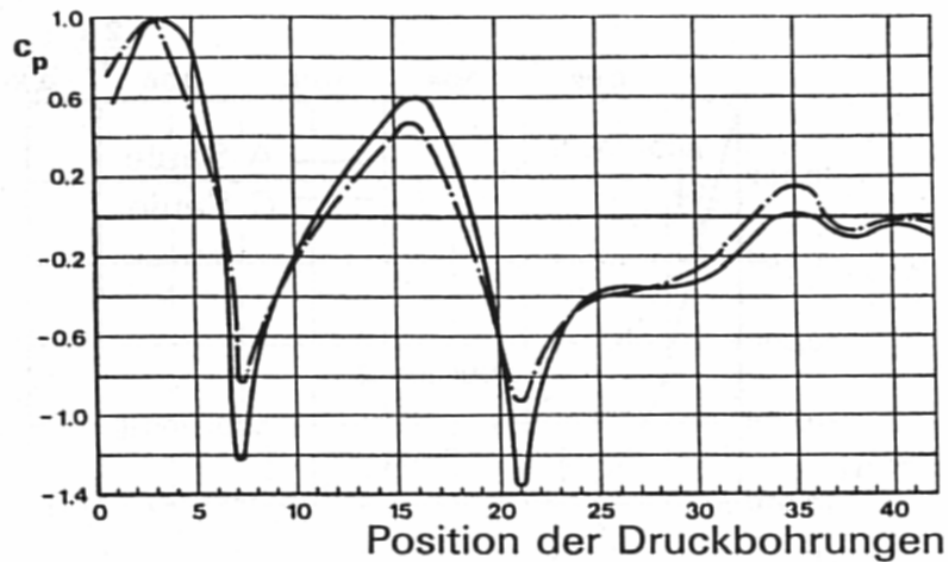

AUDI 100 II

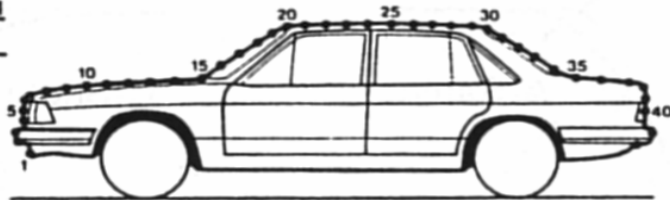

AUDI 100 III

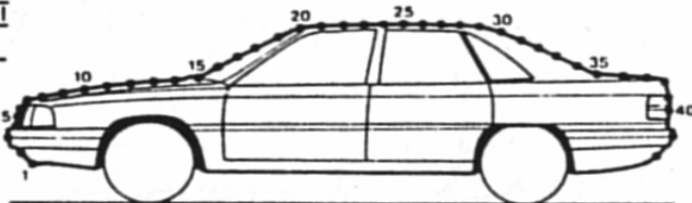

Between points

- a) 7-16 behind the leading edge,
- b) over the bonnet, in front of the windscreen
- c) 21-25 after the upper horizontal leading edge over the windscreen
- d) 1-35 behind the upper horizontal trailing edge, over the rear window

Ad a)

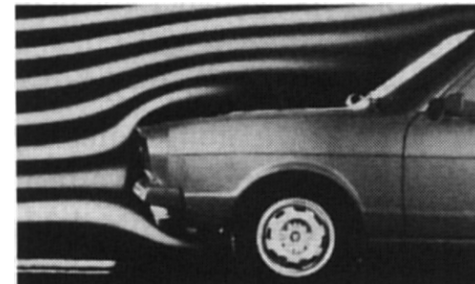

Ad b), d)



# Components of the drag of a brick shaped bluff body and their reduction

<b>Drag type</b>	<b>% of <math>c_D</math></b>	<b>Caused by</b>	<b>Way of reduction and measures</b>
Forebody drag	65%	Overpressure on the front face	Reduction of overpressure by accelerating the flow: rounding up of upper horizontal and vertical leading edges, slanting the front face
Base drag	34.9%	Depression on the rear end	Increase of pressure: boat-tailing, tapering the rear part of the body, rounding up of trailing edges
Side wall, roof and underbody drag	0.1%	Shear stresses over the walls, roof and underbody	Decrease of shear stresses: reduction of roughness, decrease of the velocity in the underbody gap

# Reduction of forebody drag (decrease of overpressure on the front) 1

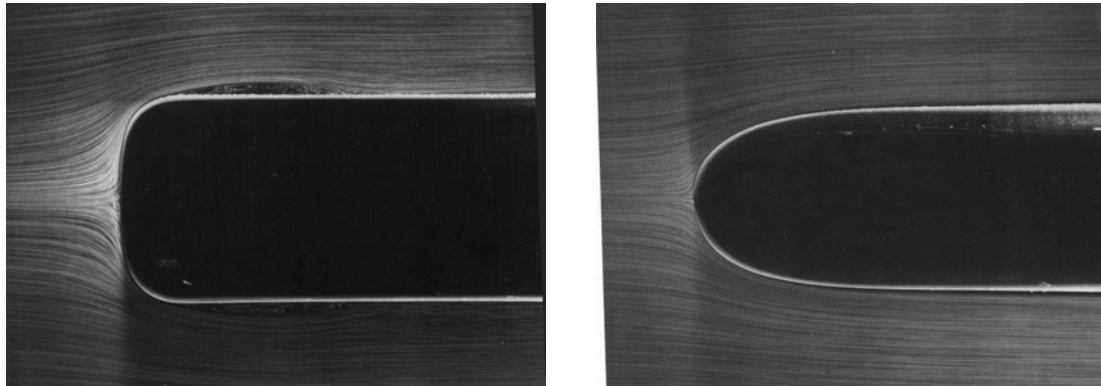

Boundary layer separation is a good indicator of high drag

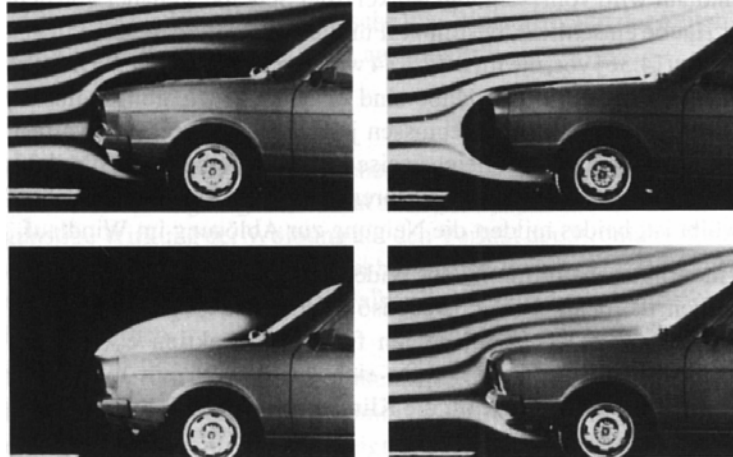

Rounding up of upper horizontal leading edge

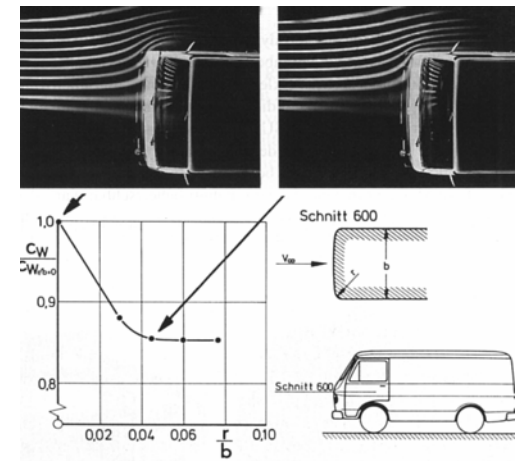
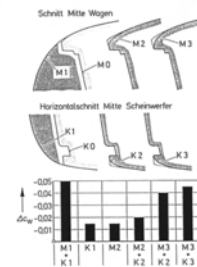
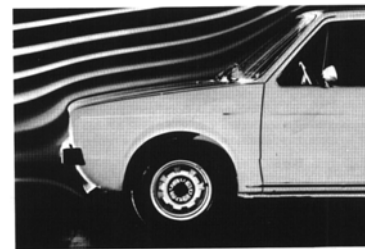

Rounding up of vertical leading edges

# Reduction of forebody drag (decrease of overpressure on the front) 2

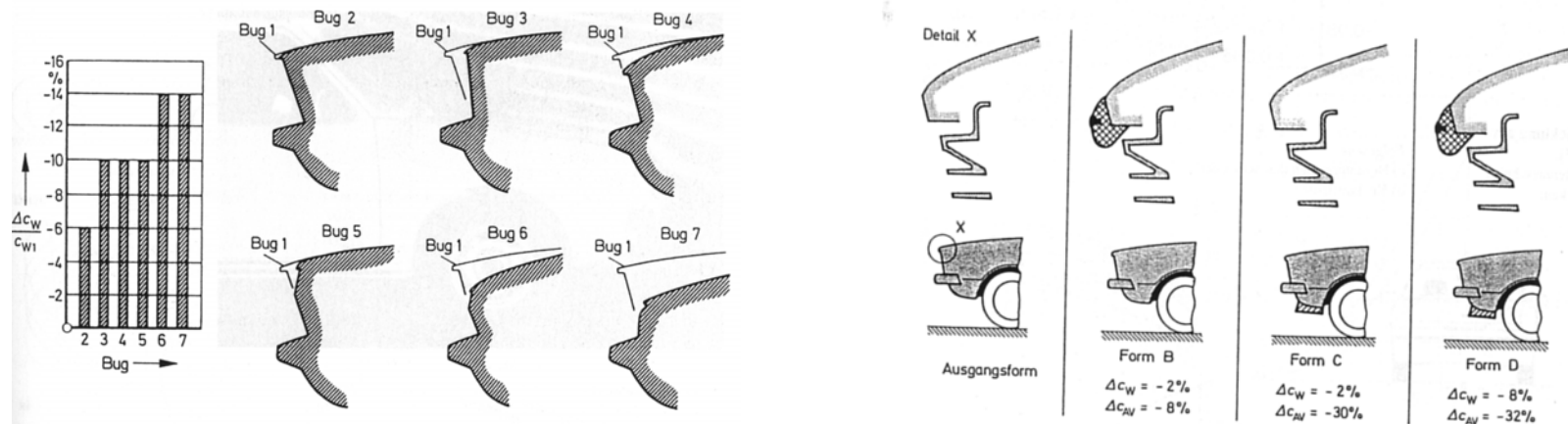

**Changing the shape of the front end**

**Use of front spoiler**

## Conclusions:

- The most significant drag reduction can be achieved by rounding up the vertical and upper horizontal leading edges on the front face.
- Relatively small amendments can result considerable drag reduction.
- The drag reduction of front spoiler is large if its use is combined with rounded leading edges.



# Reduction of base drag (increase of pressure on the rear end) 1

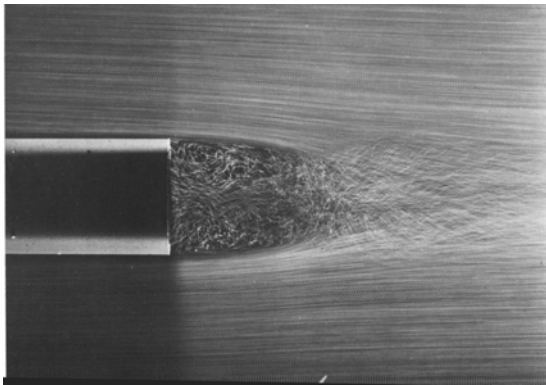

Curvature of streamlines indicates depression

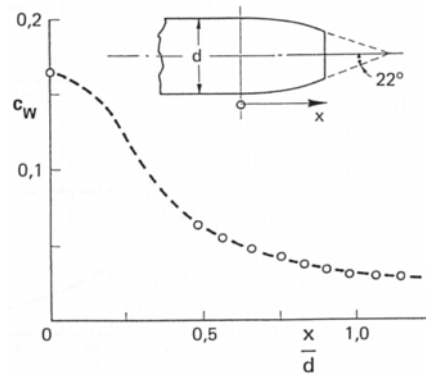

Tapering the rear end (boat tailing) results in considerable drag reduction

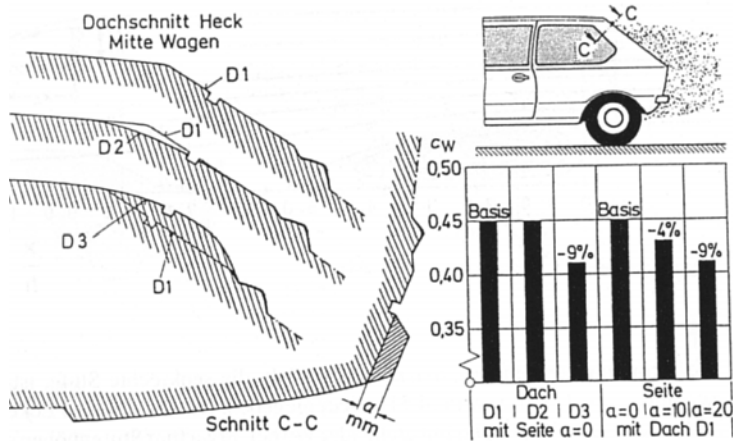
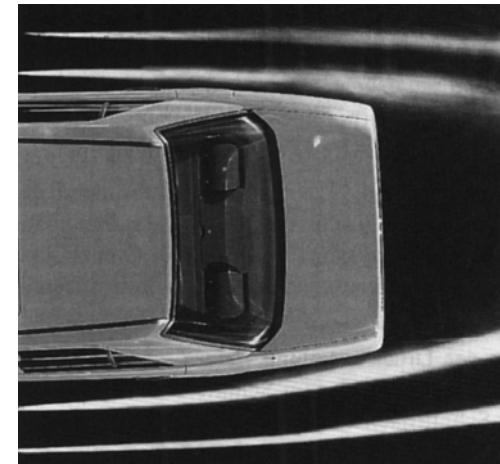

Practical realizations of tapering

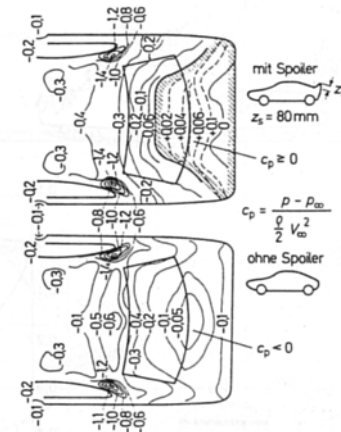

Rear spoiler increases the pressure on the rear end decreasing drag and lift

# Reduction of base drag (increase of pressure on the rear end) 2

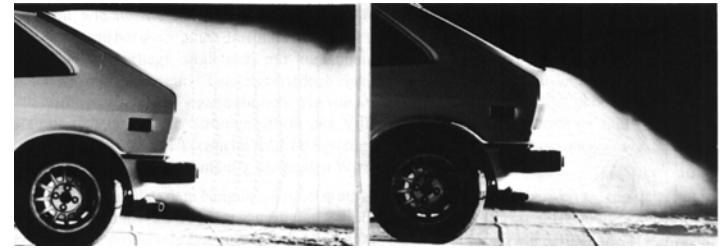
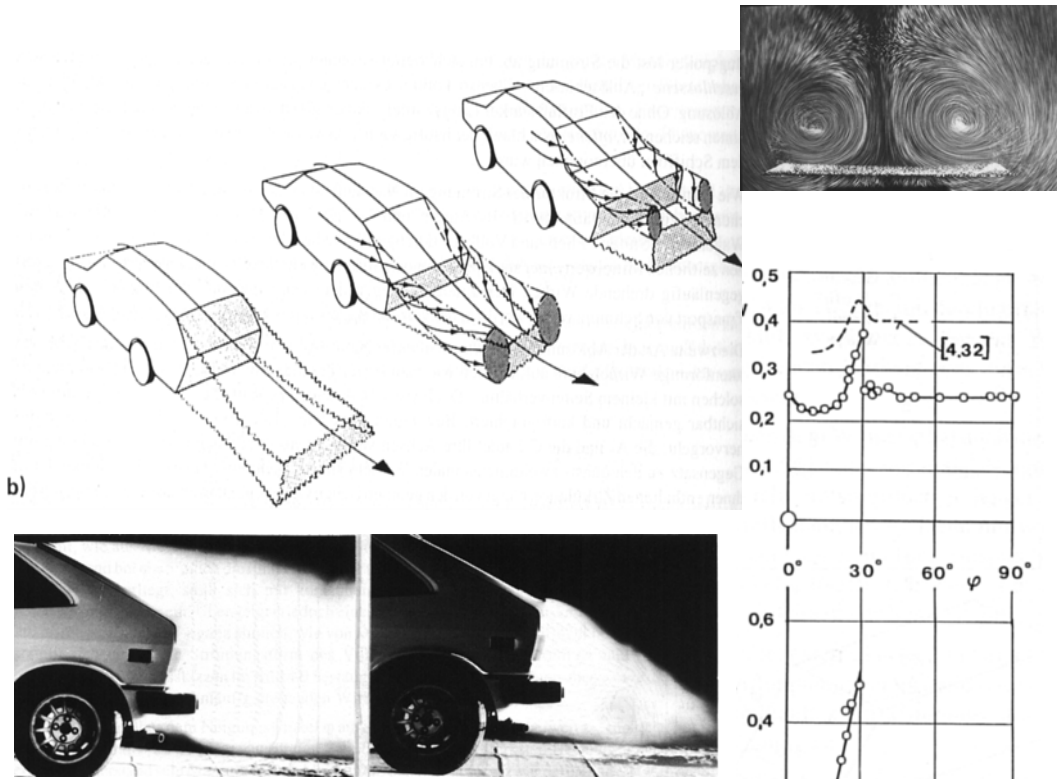

**Longitudinal vortices can develop over slanted trailing edges, causing increase of drag and lift**

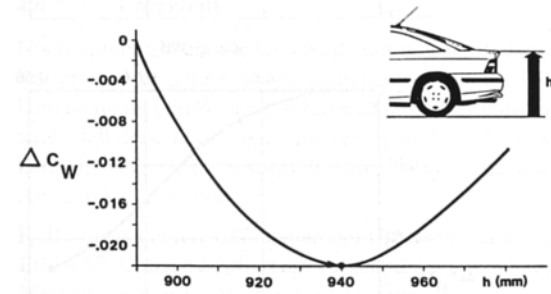

- Conclusions:**
- a) Tapering of rear part results is reduction of the size of rear separation bubble and increase of pressure
  - b) Rear spoiler and increase of boot height reduces drag and lift simultaneously
  - c) Slanted trailing edges can cause longitudinal vortices increasing the drag and lift

# Reduction of side wall, roof and underbody drag (decrease of shear stresses)

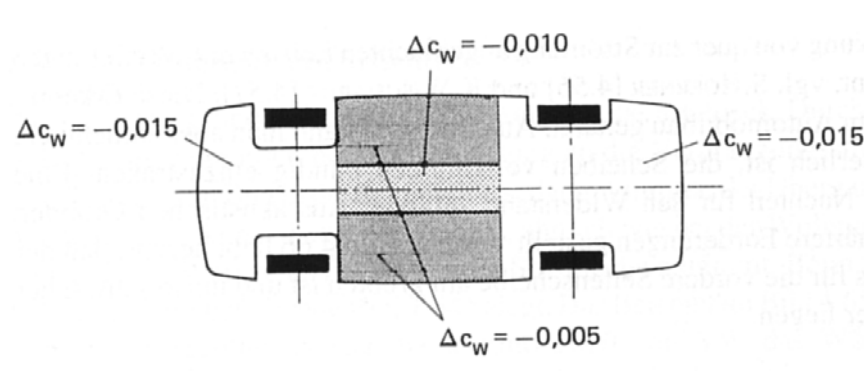





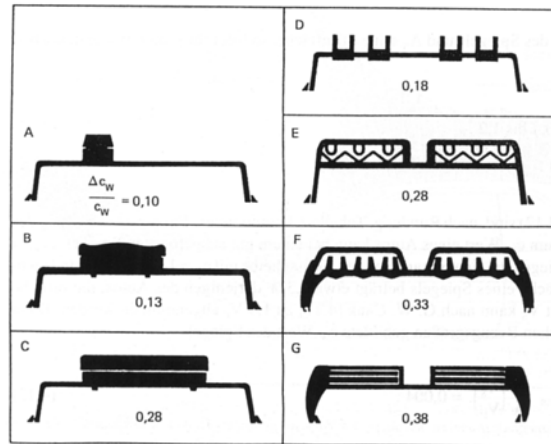

## Conclusions

- Roof and side wall drag can be reduced by reduction of roughness of the wall (no protruding parts, frames)
- Underbody drag can be reduced by reducing the roughness (covering) and reducing the velocity in underbody gap (tight underbody gap, front spoiler )

# Effect of add-on devices and limits of aerodynamic drag reduction



	
AUDI* $c_w = 0,30$	Mercedes* $c_w = 0,30$
	
FORD Probe III $c_w = 0,22$	UNI-CAR* $c_w = 0,25$
	
OPEL Tech I $c_w = 0,24$	VW* $c_w = 0,25$

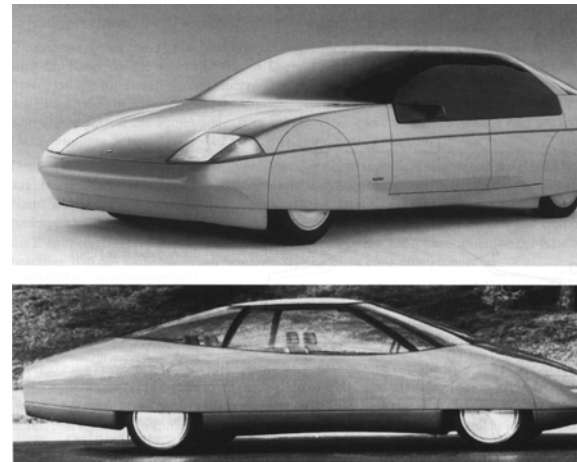
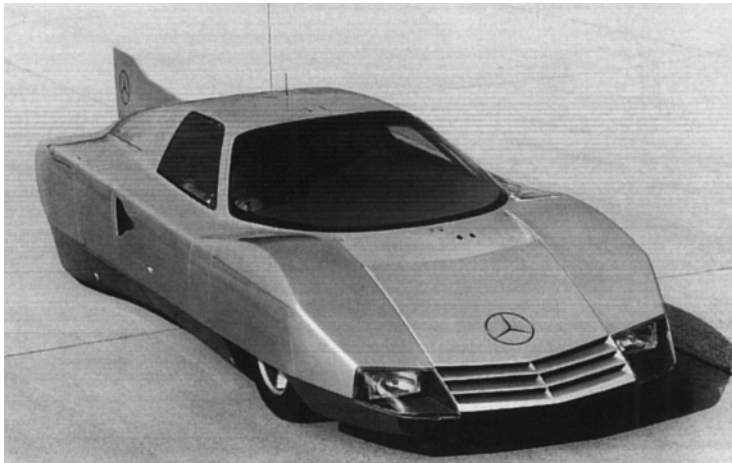

# Example: wind tunnel investigations aiming at reduction of aerodynamic drag of buses

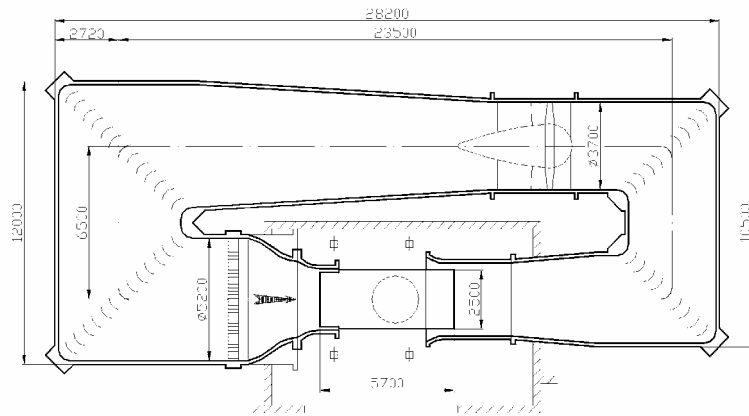

**Wind tunnel:** recirculating, 2.6 m x 5 m open test section,  $v_{\max} = 50$  m/s wind velocity, 6 component overhead balance, when necessary, ground simulation with moving belt, flow visualisation with oil smoke.

**Bus model:** 1:5 scale bus models with rotating wheels, detailed underbody and interchangeable parts.

# Result of the systematic wind tunnel tests

Change of bus body geometry	$\Delta c_e/c_e \times 100\%$
Rounding up of upper horizontal and vertical leading edges (around the front end) ( $r/h = 0.04 \Rightarrow 0.11$ )	-38%
Increase of front face slant from $8^\circ$ to $11^\circ$	-8%
Rounding up of lower horizontal leading edge and trailing edges	$\pm 0$
Covering of underbody before the front wheels	-4%
The front spoiler decreases the height of underbody gap by 38%	-(5-8)%

Decrease of drag coefficient  $c_D = 0.57 \Rightarrow 0.39$  (-32%) resulting in about 20% reduction of fuel consumption at 100km/h speed (+ less noise and mud deposition).

# Increase of driving stability 1 reducing aerodynamic lift

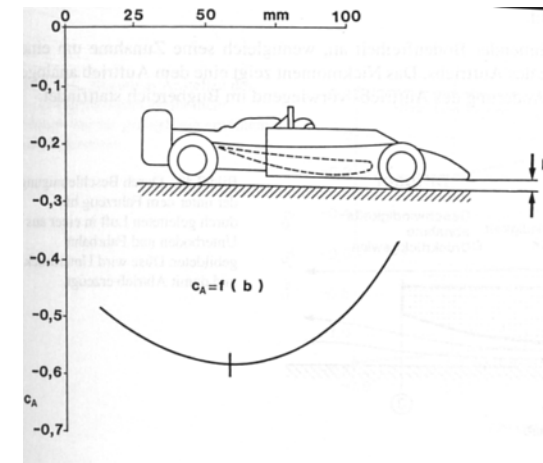
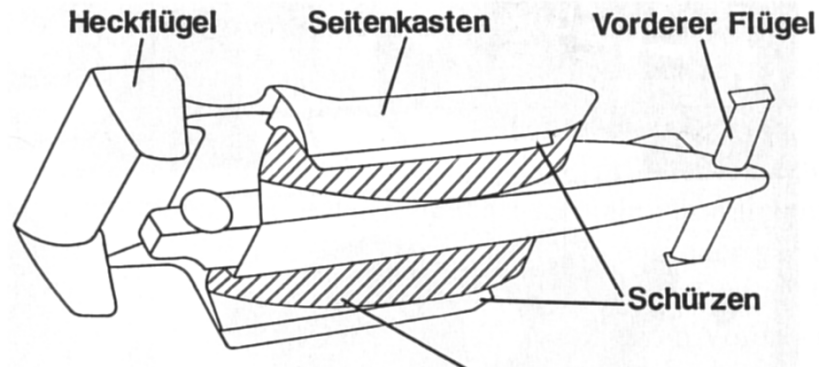

**Effect of the gap size  
on the lift**

Airfoils, side box provided with wing increase  
the negative lift:  $a_{cp} = v^2/R = 2-3$

# Increase of driving stability 2 reducing aerodynamic lift

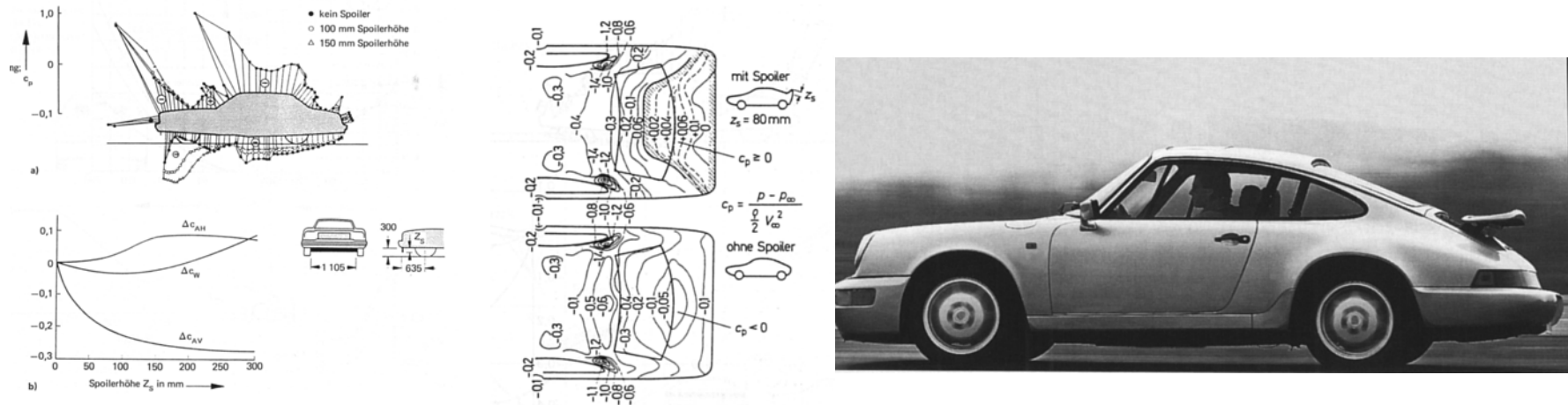

## Conclusions

- Aerodynamic lift is particularly important at high performance and racing cars where the negative lift increases the speed in curves
- Lift can be reduced by spoilers under the front bumper and at the upper horizontal trailing edge
- At racing cars airfoils and underbody devices increase the negative lift



# Increase of driving stability 3 influencing yawing moment

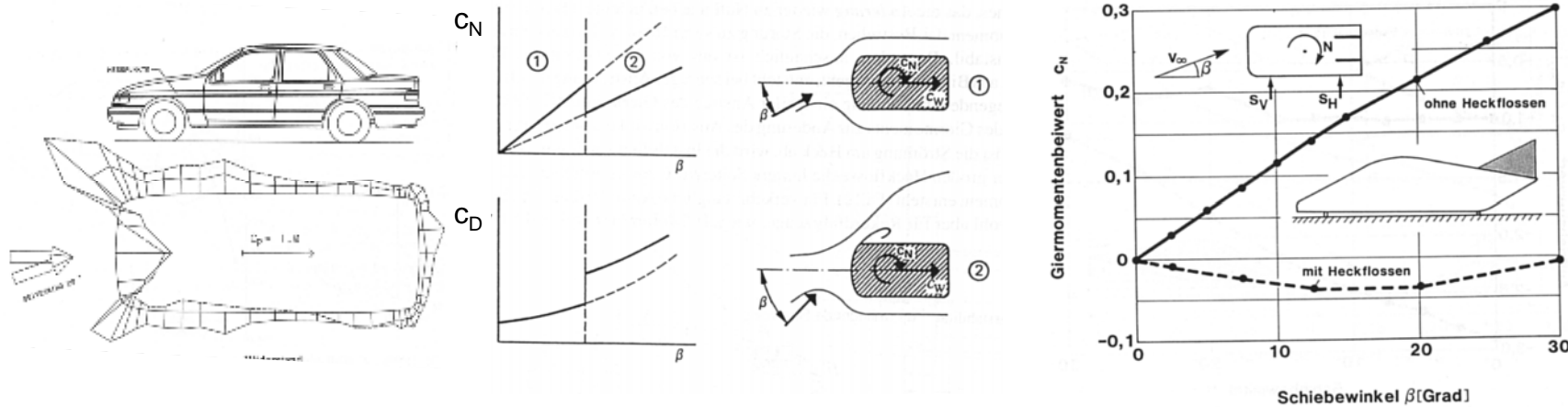

## Conclusions

- Yawing moment is caused mainly by the depression on the leeward rounded leading edge
- Yawing moment can be reduced by generating BL separation or
- By using fin at the rear part of the car

# Numerical simulation of the flow past vehicle bodies 1

FLUENT is an universal, finite volume simulation code for calculation of 3D steady and unsteady, laminar or turbulent, one or two phase flow with or without heat transfer and chemical reactions.

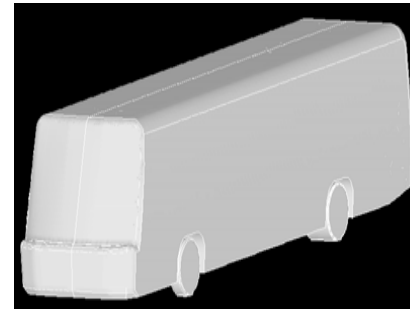
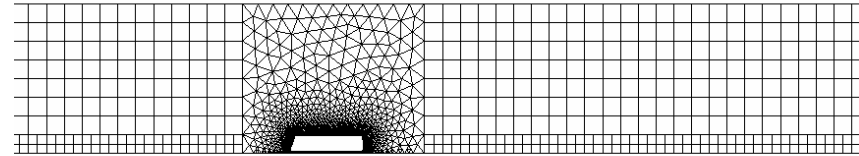

Bus surface (half) and cells in simulation domain

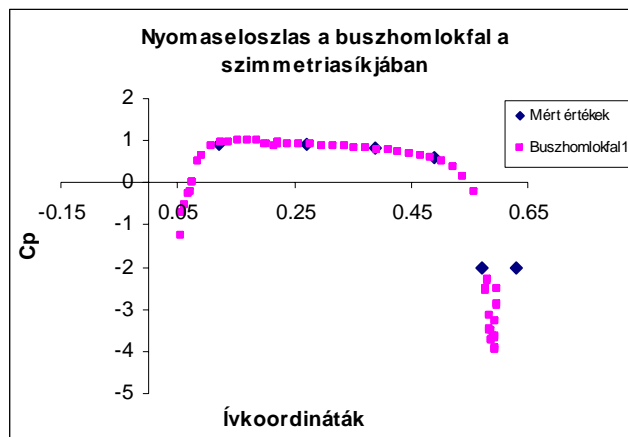

a)

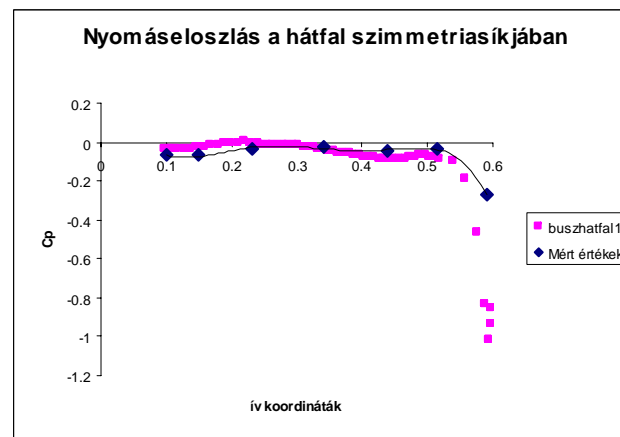

b)

Measured and calculated pressure distributions on the front a) and rear b) wall.

# Experimental investigations of mud deposition on bus body

Reduction of mud deposition on side walls and rear wall by using wind tunnel experiments

- simulation of moving ground with moving belt
- rotating wheels, detailed underbody
- Measurement of mud deposition
  - with water of increased conductivity, introduced over the moving belt: measurement of conductivity
  - measurement of concentration of tracer gas
  - flow visualisation using oil smoke



## Conclusions

Small changes in rear wall geometry reduces mud deposition on rear wall by 73%.

The area of side walls covered by mud can be reduced considerably by reducing the deceleration of underbody flow.

# Numerical simulation of mud deposition on rear wall of buses

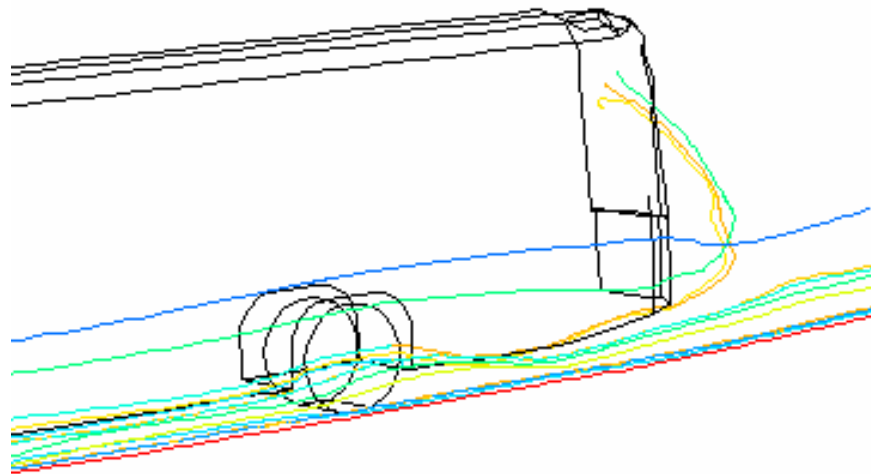

Unfavourable flow conditions  
⇒ extensive mud deposition  
on rear wall

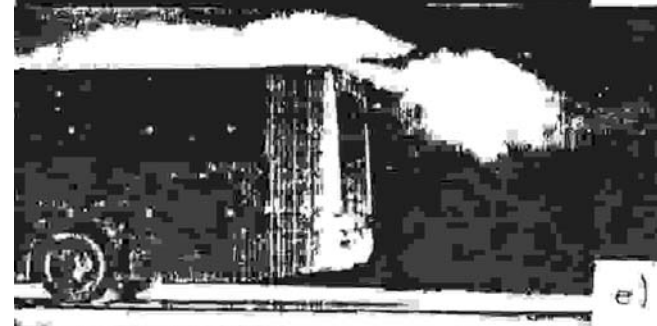
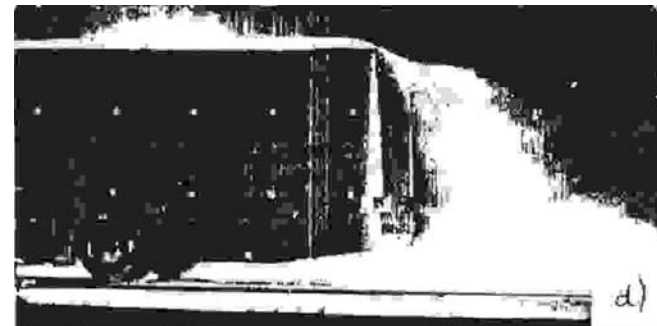
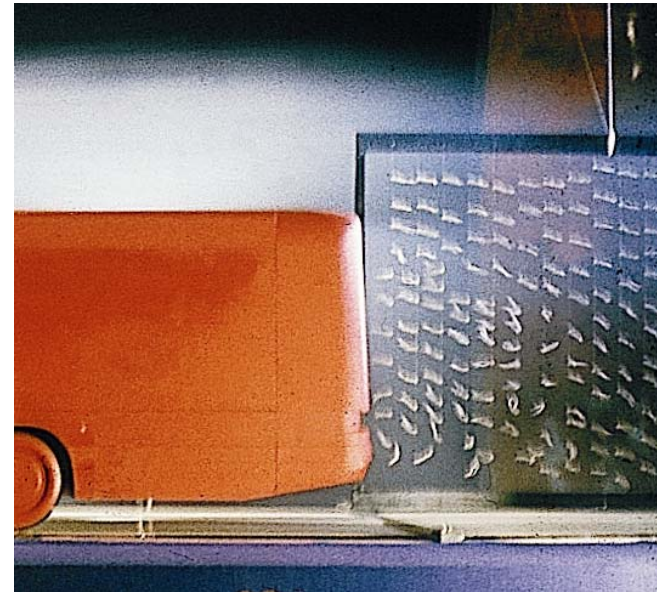

# Numerical simulation of mud deposition on rear wall of buses

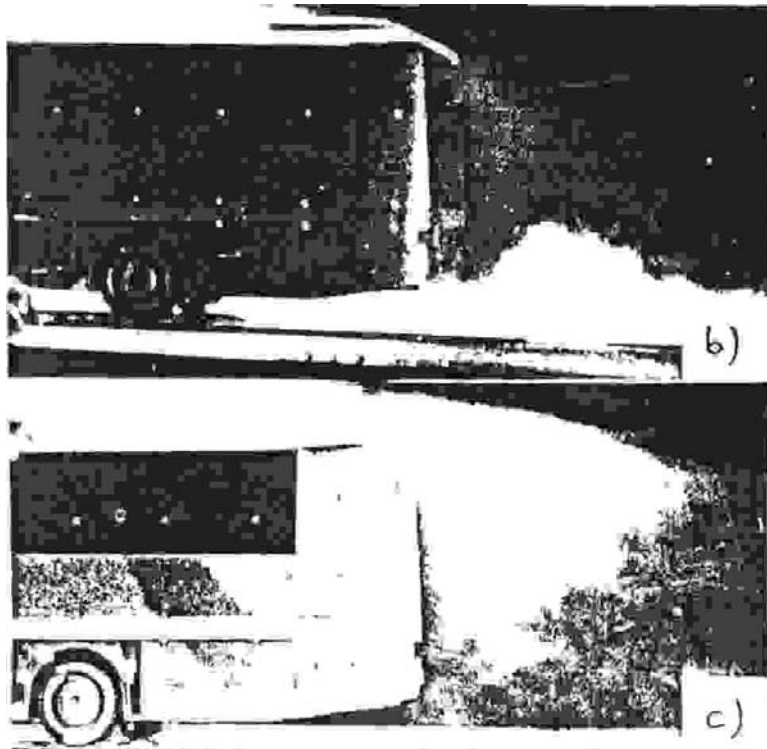

**Flow visualisation**

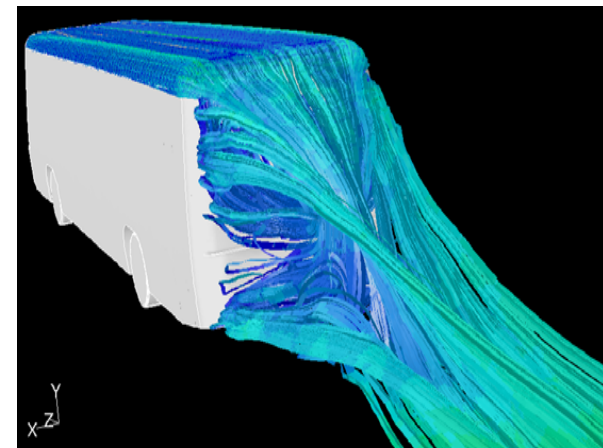
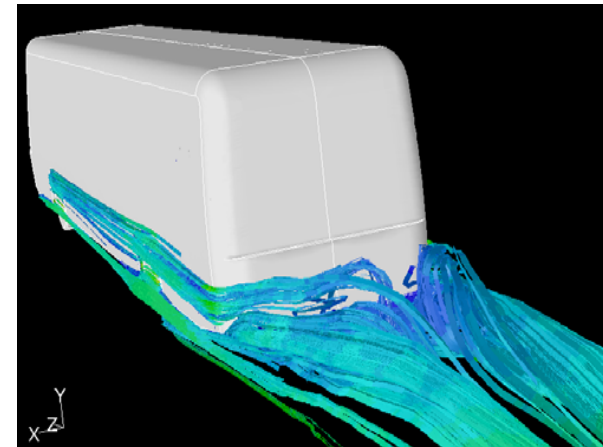

**Numerical simulation**

Favourable flow conditions  $\Rightarrow$  limited mud deposition on rear wall

# Numerical simulation of flow past isolated wheel

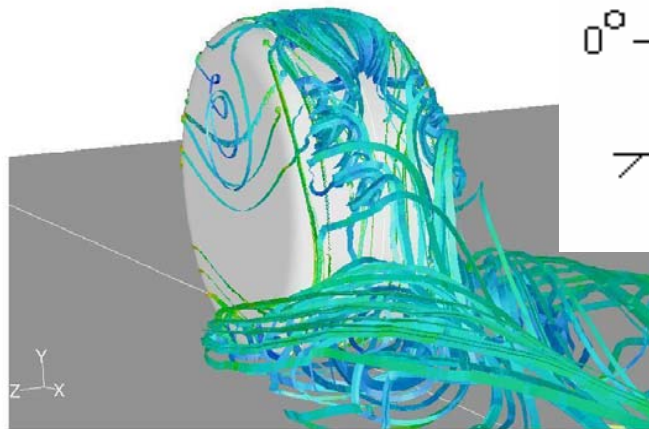

stationary

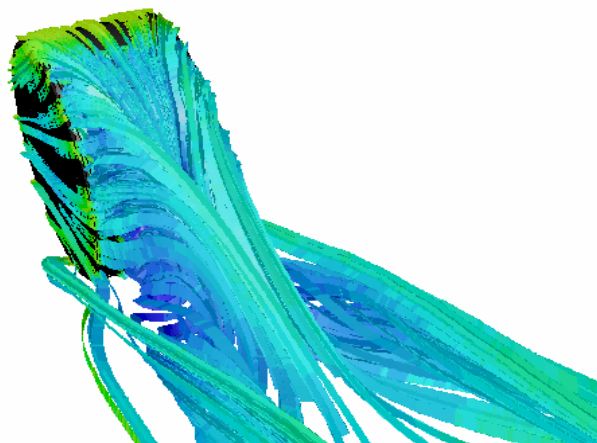
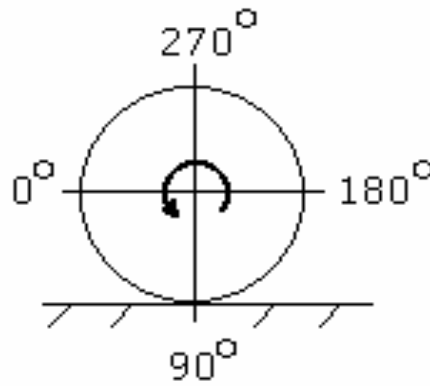

rotating

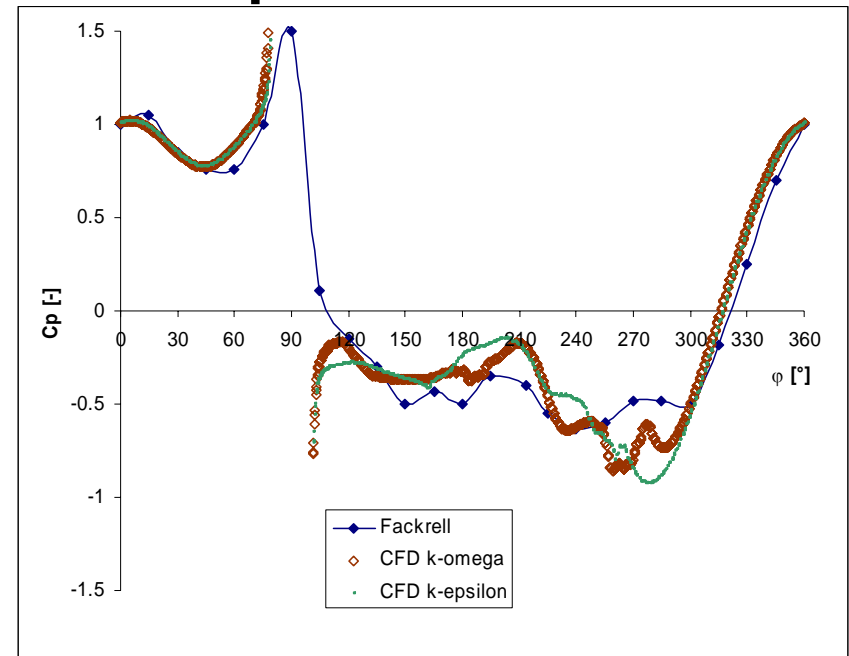

Comparison of measurement and numerical simulation

## Conclusion

Beside wind tunnel investigations numerical simulation is cost-effective and more and more reliable tool for analysing and optimising the flow past vehicle bodies.

## Conclusion

Optimisation of vehicle bodies results in

- considerable reduction of fuel consumption
- improvement of comfort characteristics and
- more favourable driving characteristics of ground vehicles.

In optimisation besides wind tunnel investigations numerical simulation of flow field has become more and more important.